

UF / UFII Internal Submerged System

Product Catalog

UF / UFII Internal Submerged System

- **UF** Internal Submerged System
- **UFII** Internal Submerged System
- **UF / UFII** Kits
- **DIONavi.** Kits

※ This catalog does not contain all products of DIO Corporation.
Please check with your local sales office order products.

UF / UFII Internal Submerged System

UF Int. Submerged System	010
UFII Int. Submerged System	014
UFII Master Kit	080
UFII Surgical Kit	081
UFII Narrow Kit	094
UFII Wide Kit	098
DIOnavi. Kits	104



UFI Internal Submerged System

UF / UFII Internal Submerged System

N Narrow

017

UF II
Narrow
Fixture



∅3.0 ∅3.3

021

Cover
Screw



022

Healing
Abutment



Cement / Screw - Retained Restorations

028

Pick-up
Impression
Coping



029

Transfer
Impression
Coping



030

Fixture
Analog



030

Temporary
Abutment



031

Cemented
Abutment



034

Angled
Abutment



035

UCLA CCM
Abutment



Cement - Retained Restorations

037

Solid
Abutment



038

Protect
Cap



038

Impression
Cap



039

Solid
Abutment
Analog



039

Plastic
Coping



Overdenture - Retained Restorations

047

Ball
Abutment



048

Ball
Abutment
Analog



048

Retainer



048

Ball Cap



048

O-Ring



049

OT Cap



049

Stainless
Steel
Housing



049

Insertion Tool
For Caps



049

Remove Tool
For Caps



050

Locator
Abutment



051

Replacement
Male



051

Extended
Replacement
Male



051

Male
Package



052

Denture
Cap



052

Black
Processing
Male



052

Block-Out
Spacer



053

Locator
Core Tool



053

Locator
Square Drive
Torque Wrench
Driver



Cement / Screw - Retained Restorations



R Regular **W** Wide



Cement / Screw - Retained Restorations

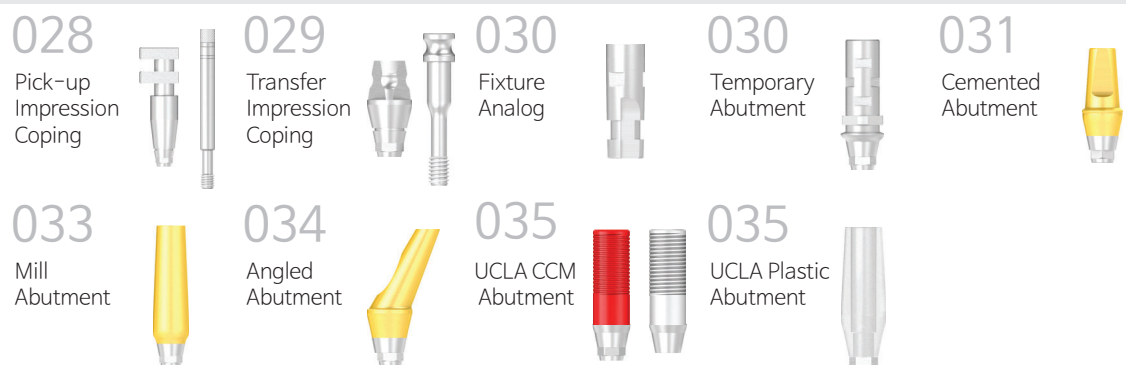

Cement - Retained Restorations



Screw - Retained Restorations



UF / UFII Internal Submerged System

Cement / Screw - Retained Restorations



Overdenture - Retained Restorations



Cement / Screw - Retained Restorations



Screw - Retained Restorations

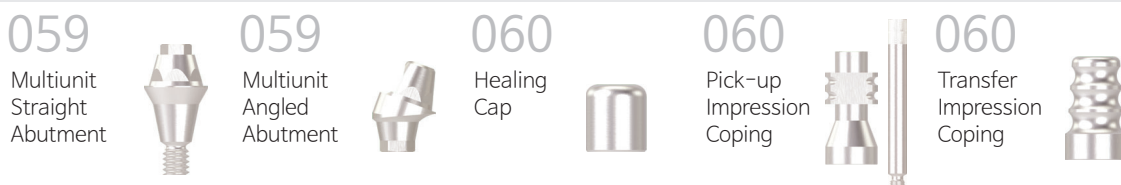

060
H-Scanbody



061
Scan Adapter



061
Cylinder Protector



062
Cemented Cylinder



062
Plastic Cylinder



062
Temporary Cylinder



063
Cylinder Screw



063
Abutment Analog



063
Digital Analog



Digital Materials

Digital Abutment

065
Lower Incisor
Narrow
Angled
Abutment



066
Upper Incisor
Narrow
Angled
Abutment



067
Upper Incisor
Angled
Abutment



068
Canine
Angled
Abutment



069
Pre-Molar
Angled
Abutment



070
Molar
Angled
Abutment



H-Scanbody

073
UF II Int. Sub.



Scan Adapter

075
UF II
Int. Sub.
Narrow



075
UF II
Int. Sub.
Regular
Wide



Scan Retractor

076
Scan
Retractor



076
Wax
Denture



076
Marker



Pre-Milled Bar

077
UF II
Int. Sub.
Narrow



077
UF II
Int. Sub.
Regular
Wide



Hybrid Link

078
UF II
Int. Sub.
Narrow



078
UF II
Int. Sub.
Regular
Wide

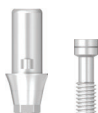

Digital Fixture Analog

079
UF II
Int. Sub.
Narrow



079
UF II
Int. Sub.
Regular
Wide



UF / UFII Internal Submerged System

UF II Surgical Kit

080

UF II Master Kit

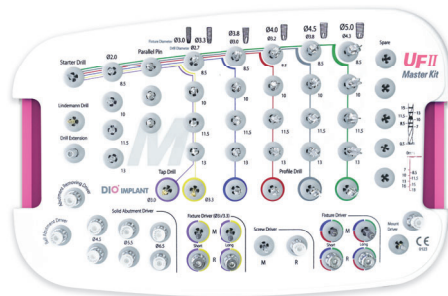

081

UF II Surgical Kit

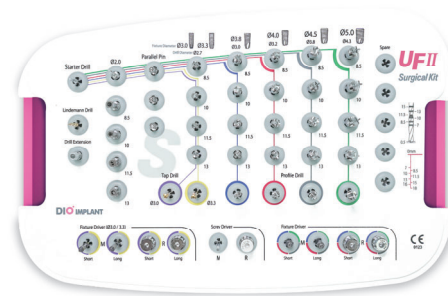

094

UF II Narrow Kit

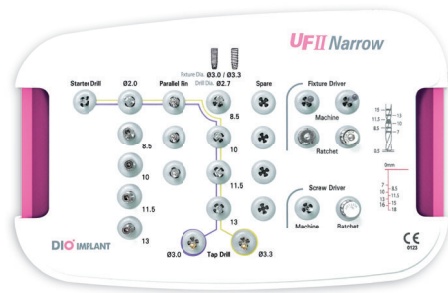

098

UF II Wide Kit

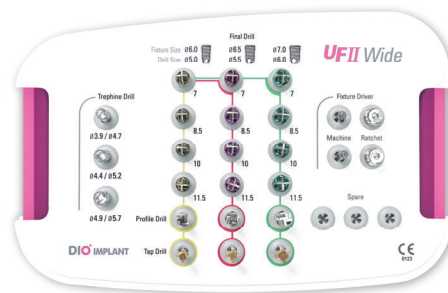

DIONavi. Surgical Kit

104

DIONavi. Master Kit

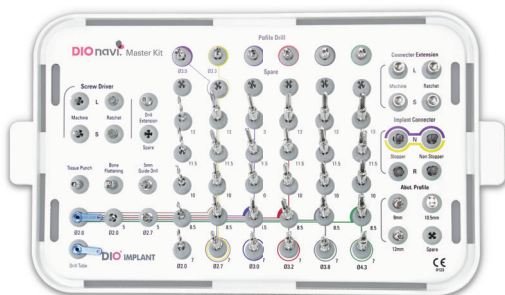

113

DIONavi. Narrow Kit

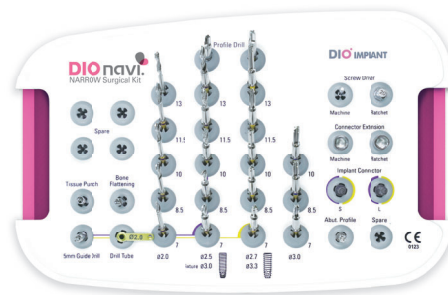

UF Int. Submerged System ^{NEW}

Surface Treatment Feature

Hybrid Type SLA Implant

UF Implant ^{NEW}

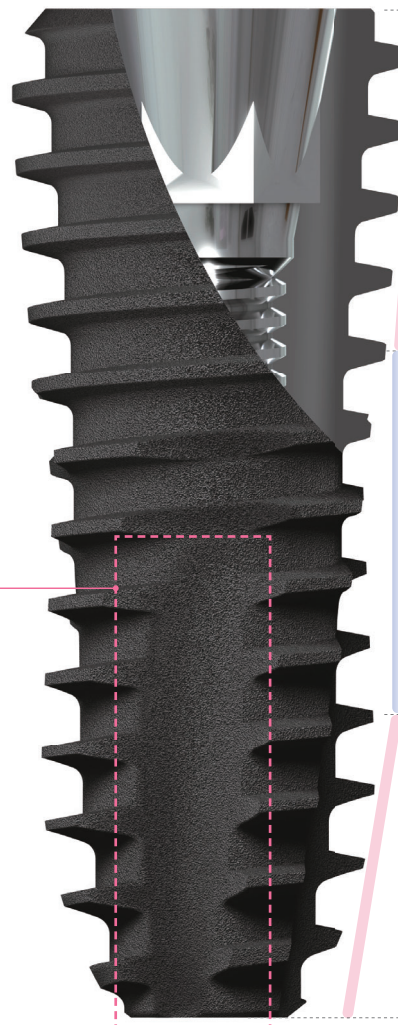
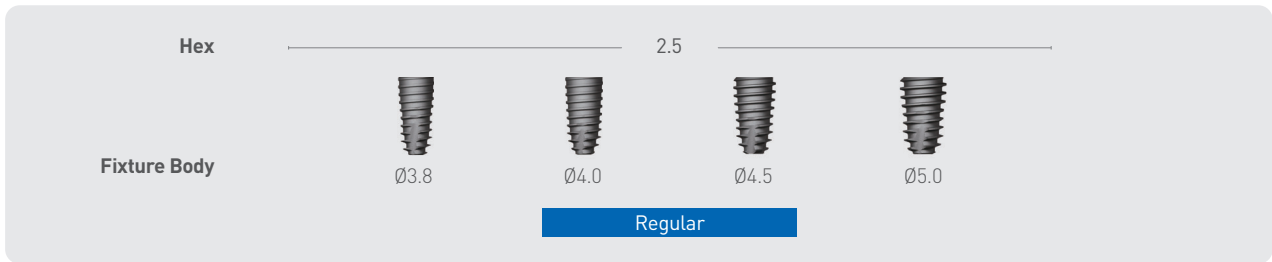

Sharp Cutting Edge

The sharp cutting edge can increase the self-tapping efficiency with minimal drilling.

Tapered Body, Tapered Thread

Tapered thread aids initial fixation

Tapered thread is applied to the tapered body to effectively disperse stress that is applied on the top of the fixture. The depth of the thread is gradually reduced as it goes to the top to decrease bone heating on the cortical bone.

Straight Body

Decreases Bone Damage

The change in the body length changed the length of the fixture, so it can be placed stably just like a straight type implant.

Long Tapered Apex

Gradually Tapered Guide

Tapered section is designed at length, so it is easy for initial entry at soft bone with under drilling.

Hybrid Type SLA Implant

UF Implant Surface HSA

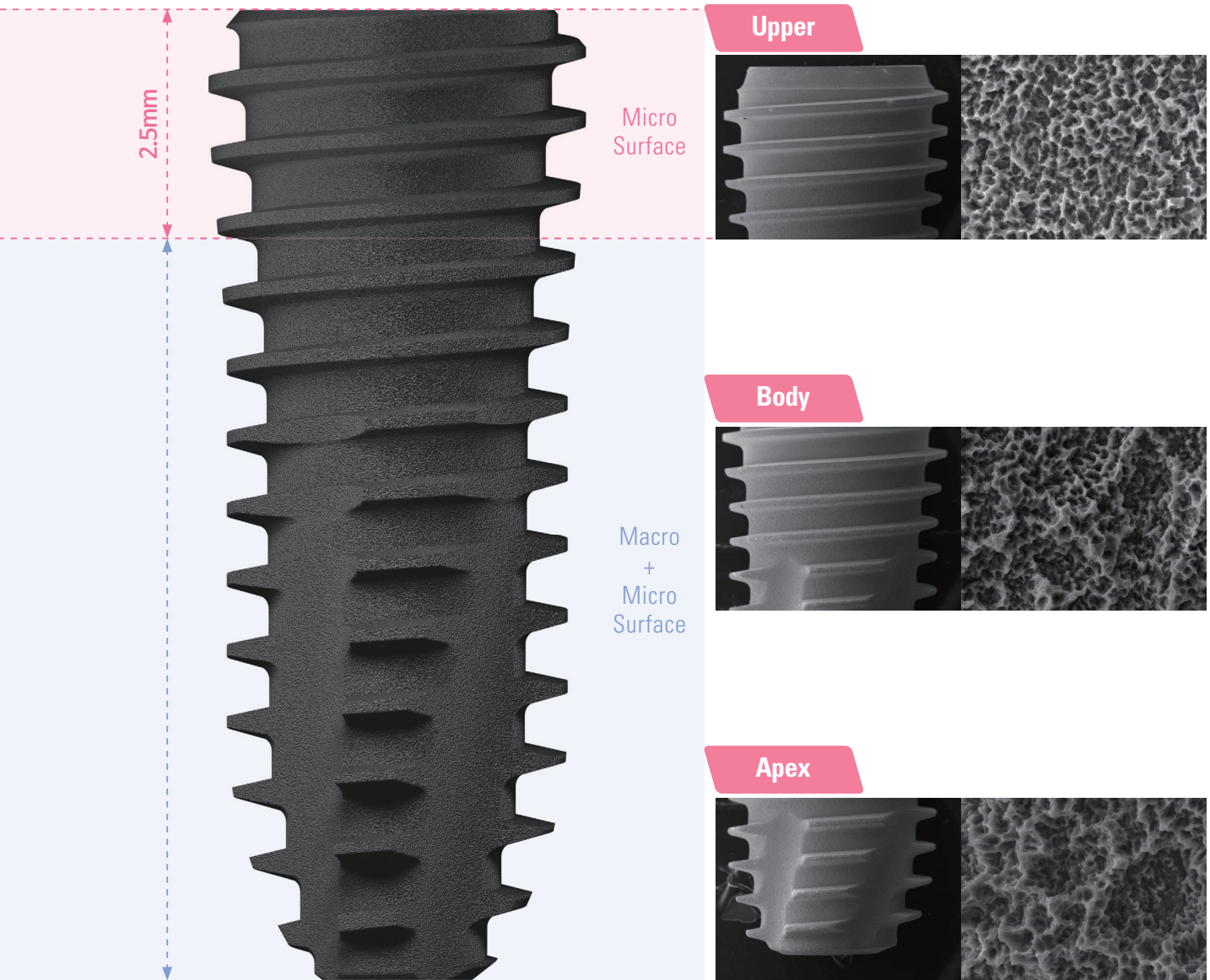

UF Int. Submerged System ^{NEW}

UF Regular

D Ø3.8 | Ø4.0 | Ø4.5 | Ø5.0

L 7 | 8.5 | 10 | 11.5 | 13

HSA

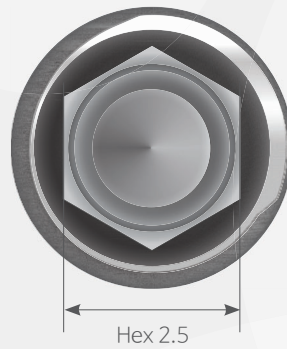

Open thread

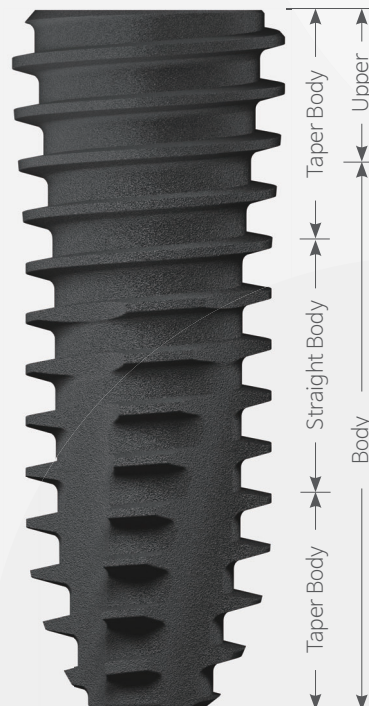



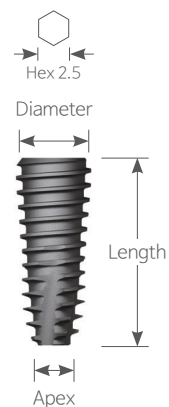

Regular Fixture

- HSA / Packing Unit : Fixture | Order code : UF 0000SF (ex : UF 3808SF)
- Fixture + Cover Screw | Order code : UF 0000S (ex : UF 3808S)







R D Ø3.8 Hex 2.5 Apex Ø1.4





Unit mm | Scale 1 : 1.2

Length	7	8.5	10	11.5	13
					
HSA	-	UF 3808SF	UF 3810SF	UF 3811SF	UF 3813SF

R D Ø4.0 Hex 2.5 Apex Ø1.6





Length	7	8.5	10	11.5	13
					
HSA	UF 4007SF	UF 4008SF	UF 4010SF	UF 4011SF	UF 4013SF

R D Ø4.5 Hex 2.5 Apex Ø1.6

Length	7	8.5	10	11.5	13
					
HSA	UF 4507SF	UF 4508SF	UF 4510SF	UF 4511SF	UF 4513SF

R D Ø5.0 Hex 2.5 Apex Ø2.0

Unit mm | Scale 1 : 1.2

Length	7	8.5	10	11.5	13
					
HSA	UF 5007SF	UF 5008SF	UF 5010SF	UF 5011SF	UF 5013SF

UFII Int. Submerged System

Hybrid Type SLA Implant

UFII Implant

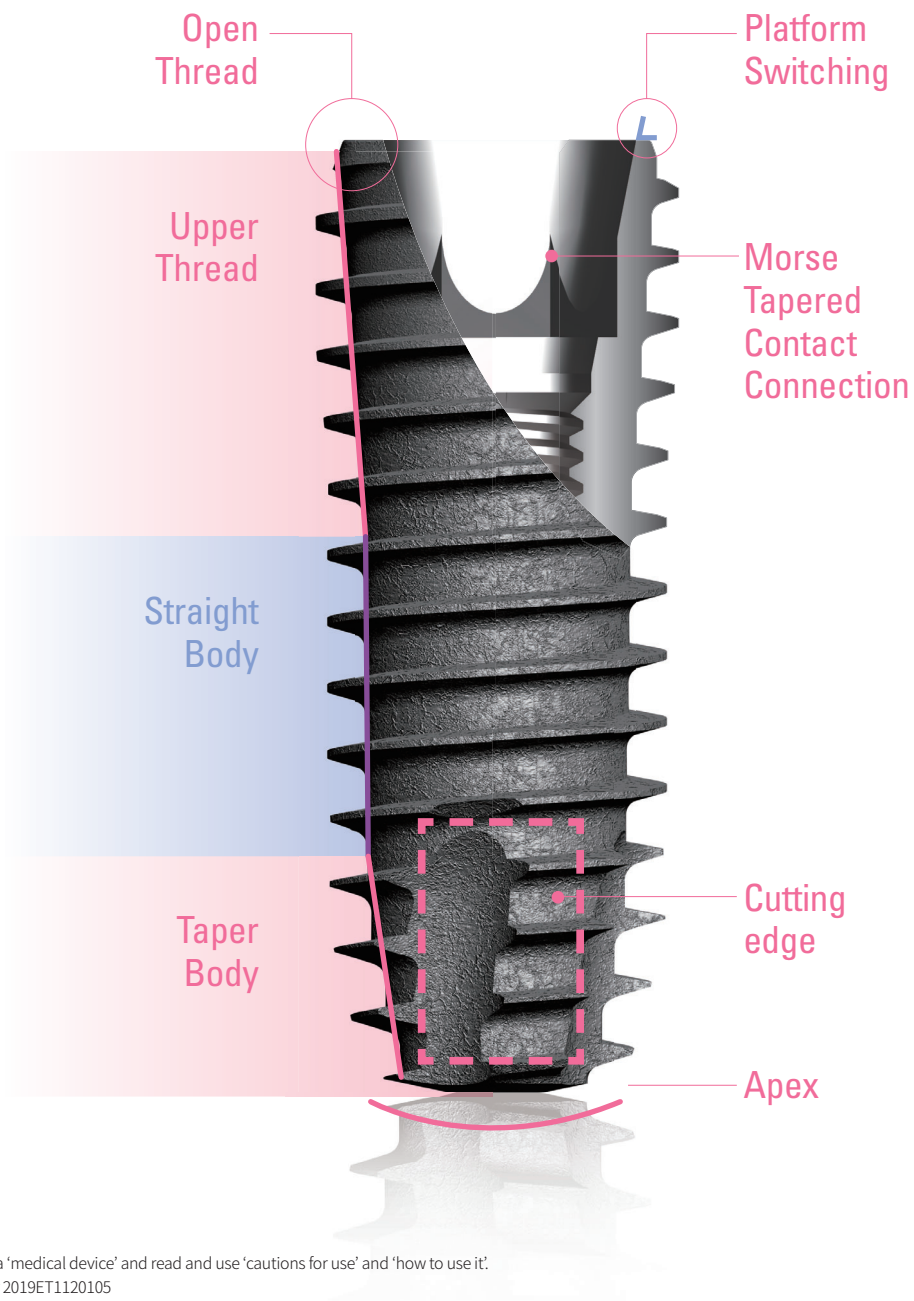
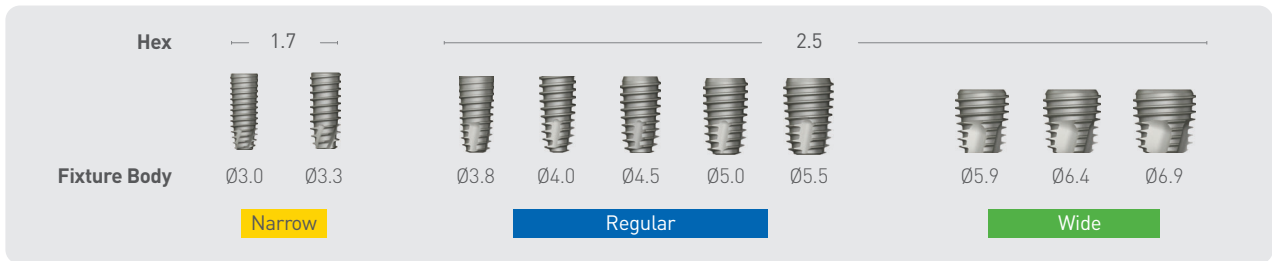

Hybrid Type SLA Implant

UFII Implant Surface HSA

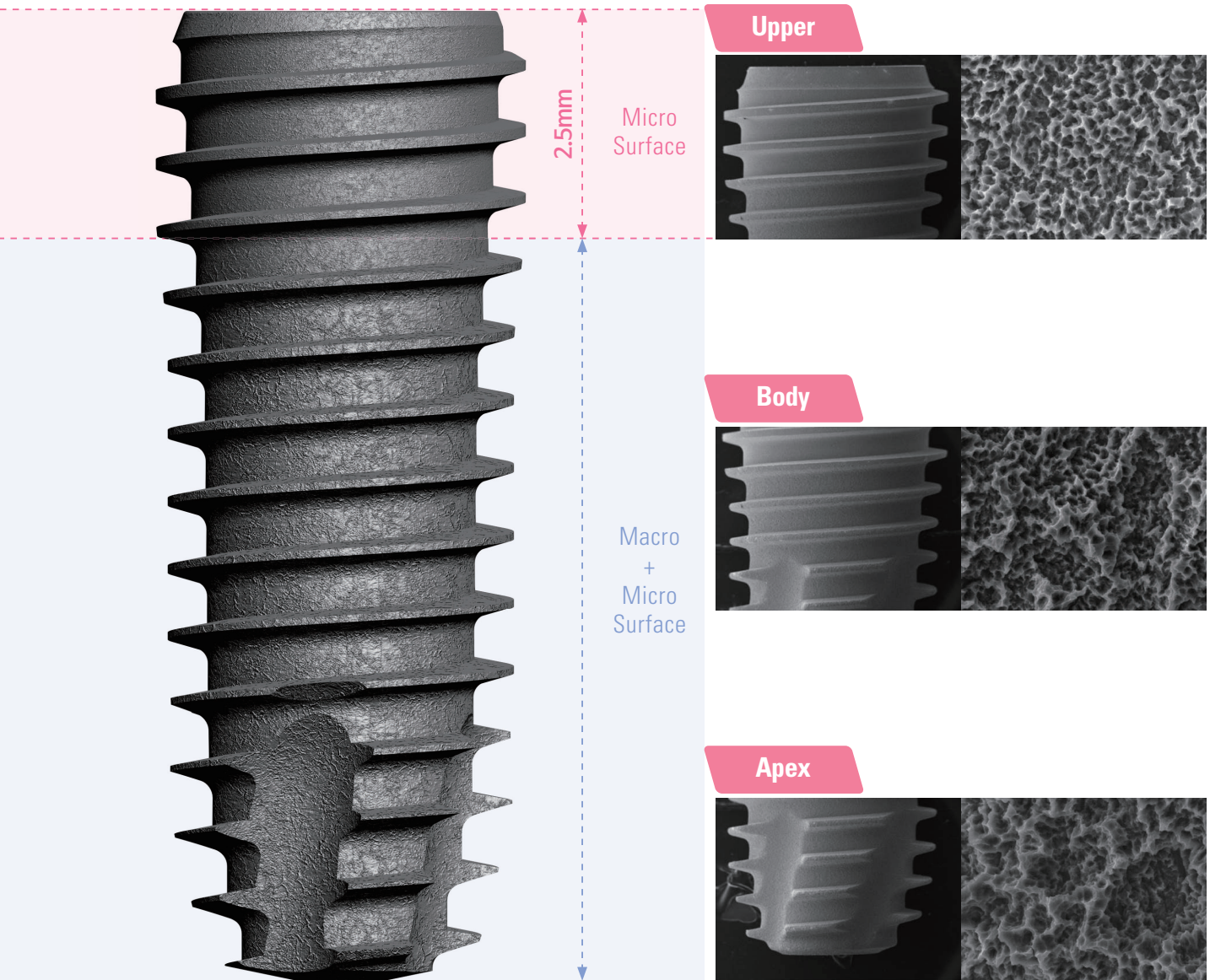

UFII Internal Submerged System

UFII Narrow

D $\emptyset 3.0$ | $\emptyset 3.3$
 L 8.5 | 10 | 11.5 | 13 | 15

HSA

UVActive

UFII Regular

D $\emptyset 3.8$ | $\emptyset 4.0$ | $\emptyset 4.5$ | $\emptyset 5.0$ | $\emptyset 5.5$
 L 7 | 8.5 | 10 | 11.5 | 13 | 15

HSA

UVActive

UFII Wide

D $\emptyset 5.9$ | $\emptyset 6.4$ | $\emptyset 6.9$
 L 7 | 8.5 | 10 | 11.5 | 13 | 15

HSA

UVActive

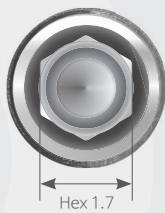

Hex 1.7

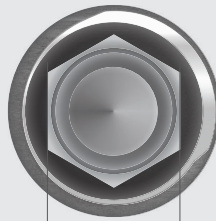

Hex 2.5

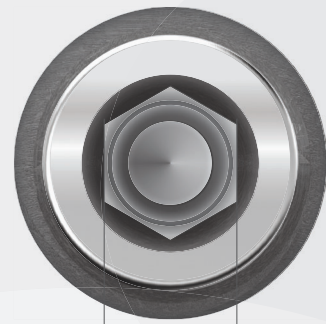

Hex 2.5

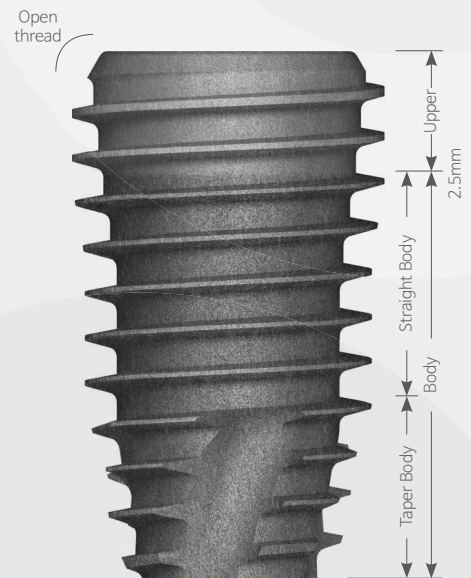
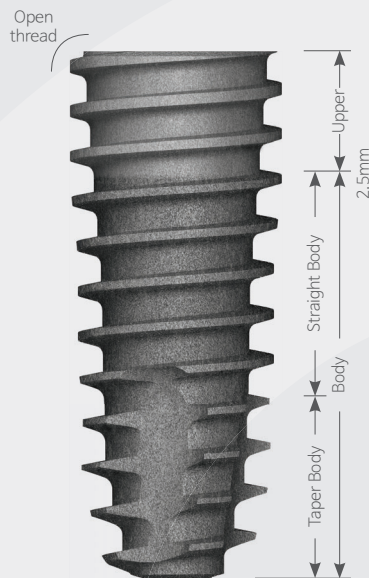
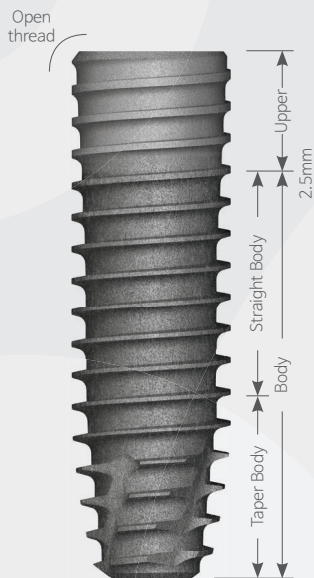

UFII Narrow

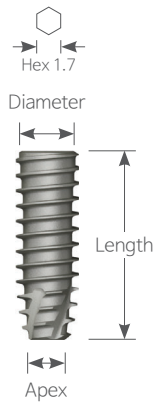

UFII Regular

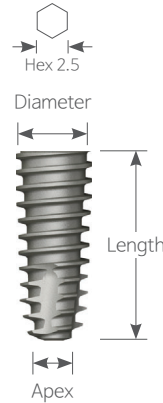

UFII Wide

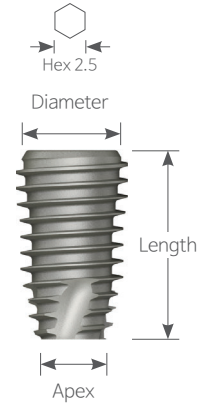





Narrow Fixture

► $\varnothing 3.0$ fixture exclusive for anterior region.

- HSA / Packing Unit : Fixture | Order code : UF(II)N 0000**SF** (ex : UF(II)N 3008**SF**)
Fixture + Cover Screw | Order code : UF(II)N 0000**S** (ex : UF(II)N 3008**S**)
- UV Active / Packing Unit : Fixture | Order code : UF(II)N 0000**UV3** (ex : UF(II)N 3008**UV3**)
- Accessories : Cover Screw (UNSCS 2700)





N D $\varnothing 3.0$ Hex 1.7 Apex $\varnothing 1.6$

Unit mm | Scale 1 : 1.2

Length	8.5	10	11.5	13	15
					

HSA | UF(II)N 3008**SF** UF(II)N 3010**SF** UF(II)N 3011**SF** UF(II)N 3013**SF** UF(II)N 3015**SF**
 UV Active | UF(II)N 3008**UV3** UF(II)N 3010**UV3** UF(II)N 3011**UV3** UF(II)N 3013**UV3** -





N D $\varnothing 3.3$ Hex 1.7 Apex $\varnothing 1.9$





Length	8.5	10	11.5	13	15
					







HSA | UF(II)N 3308**SF** UF(II)N 3310**SF** UF(II)N 3311**SF** UF(II)N 3313**SF** UF(II)N 3315**SF**
 UV Active | UF(II)N 3308**UV3** UF(II)N 3310**UV3** UF(II)N 3311**UV3** UF(II)N 3313**UV3** -

Regular Fixture







- HSA / Packing Unit : Fixture | Order code : UF(II) 0000**SF** (ex : UF(II) 3808**SF**)
 Fixture + Cover Screw | Order code : UF(II) 0000**S** (ex : UF(II) 3808**S**)
 Fixture Mount + Mount Screw + Fixture + Cover Screw | Order code : PUF(II) 0000**S** (ex : PUF(II) 3808**S**)
- UV Active / Packing Unit : Fixture | Order code : UF(II) 0000**UV3** (ex : UF(II) 3808**UV3**)
- Accessories : Cover Screw (SSCS 3400)

		R D Ø3.8 Hex 2.5 Apex Ø1.4						Unit mm Scale 1 : 1.2
Length		7	8.5	10	11.5	13	15	
								
HSA		-	UF(II) 3808 SF	UF(II) 3810 SF	UF(II) 3811 SF	UF(II) 3813 SF	UF(II) 3815 SF	
UV Active		-	UF(II) 3808 UV3	UF(II) 3810 UV3	UF(II) 3811 UV3	UF(II) 3813 UV3	-	







		R D Ø4.0 Hex 2.5 Apex Ø1.6					
Length		7	8.5	10	11.5	13	15
							
HSA		-	UF(II) 4008 SF	UF(II) 4010 SF	UF(II) 4011 SF	UF(II) 4013 SF	UF(II) 4015 SF
UV Active		-	UF(II) 4008 UV3	UF(II) 4010 UV3	UF(II) 4011 UV3	UF(II) 4013 UV3	-

		R D Ø4.5 Hex 2.5 Apex Ø1.6					
Length		7	8.5	10	11.5	13	15
							
HSA		UF(II) 4507 SF	UF(II) 4508 SF	UF(II) 4510 SF	UF(II) 4511 SF	UF(II) 4513 SF	UF(II) 4515 SF
UV Active		UF(II) 4507 UV3	UF(II) 4508 UV3	UF(II) 4510 UV3	UF(II) 4511 UV3	UF(II) 4513 UV3	-

R D Ø5.0 Hex 2.5 Apex Ø2.0

Length	7	8.5	10	11.5	13	15
						
HSA	UF(II) 5007SF	UF(II) 5008SF	UF(II) 5010SF	UF(II) 5011SF	UF(II) 5013SF	UF(II) 5015SF
UV Active	UF(II) 5007UV3	UF(II) 5008UV3	UF(II) 5010UV3	UF(II) 5011UV3	UF(II) 5013UV3	-

R D Ø5.5 Hex 2.5 Apex Ø2.5







Length	7	8.5	10	11.5	13	15
						
HSA	UF(II) 5507SF	UF(II) 5508SF	UF(II) 5510SF	UF(II) 5511SF	UF(II) 5513SF	UF(II) 5515SF
UV Active	UF(II) 5507UV3	UF(II) 5508UV3	UF(II) 5510UV3	UF(II) 5511UV3	UF(II) 5513UV3	-

Wide Fixture







- HSA / Packing Unit : Fixture | Order code : UF(II) 0000**SF** (ex : UF(II) 6007**SF**)
 Fixture + Cover Screw | Order code : UF(II) 0000**S** (ex : UF(II) 6007**S**)
 Fixture Mount + Mount Screw + Fixture + Cover Screw | Order code : PUF(II) 0000**S** (ex : PUF(II) 6007**S**)
- UV Active / Packing Unit : Fixture | Order code : UF(II) 0000**UV3** (ex : UF(II) 6007**UV3**)
- Accessories : Cover Screw (SSCS 3400)

W **D** Ø5.9 Hex 2.5 Apex Ø3.6







Unit mm | Scale 1 : 1.2

Length	7	8.5	10	11.5	13	15
						
HSA	UF(II) 6007 SF	UF(II) 6008 SF	UF(II) 6010 SF	UF(II) 6011 SF	UF(II) 6013 SF	UF(II) 6015 SF
UV Active	UF(II) 6007 UV3	UF(II) 6008 UV3	UF(II) 6010 UV3	UF(II) 6011 UV3	UF(II) 6013 UV3	-

W **D** Ø6.4 Hex 2.5 Apex Ø3.6

Length	7	8.5	10	11.5	13	15
						
HSA	UF(II) 6507 SF	UF(II) 6508 SF	UF(II) 6510 SF	UF(II) 6511 SF	UF(II) 6513 SF	UF(II) 6515 SF
UV Active	UF(II) 6507 UV3	UF(II) 6508 UV3	UF(II) 6510 UV3	UF(II) 6511 UV3	UF(II) 6513 UV3	-

W **D** Ø6.9 Hex 2.5 Apex Ø3.6

Length	7	8.5	10	11.5	13	15
						
HSA	UF(II) 7007 SF	UF(II) 7008 SF	UF(II) 7010 SF	UF(II) 7011 SF	UF(II) 7013 SF	UF(II) 7015 SF

Cover Screw

- ▶ Used for narrow area after the Implant surgery or protecting Implant connection area.
- ▶ Dental Implant cover screw is implanted into the top which helps to prevent tissue and bone to grow inside the implant.

- Uses 1.2 Hex Driver
- Method of use
 - ① Screw installation after removing the remaining blood or foreign substance in Implant.
 - ② Connect the screw using 1.2 hex driver and hand-tighten (5~8Ncm)
- Tightening Torque : 5~8Ncm
- Packing Unit : 1 Set (6 Pieces) | Order code : UNSCS 0000S or SSCS 0000S (ex : UNSCS 2700S)

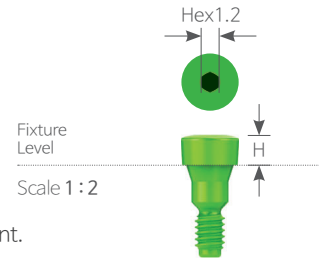

N R W Hex 1.2		Unit mm Scale 1 : 1.25	
Fixture Size	Narrow	Regular · Wide	
Height 0	UNSCS 2700	SSCS 3400	-
1	UNSCS 2710	-	SSCS 3410
2	UNSCS 2720	-	SSCS 3420
3	UNSCS 2730	-	SSCS 3430

Bone Forming Cover Screw

- ▶ the Bone Forming Cover Screw is then used to cover the bonegraft to protect it from your tongue and saliva.
- ▶ Make a buccal incision (instead of a midcrestal incision) for better access to keratinized mucosa.
- Concave transmucosal profile make enough space for bone graft.
- 2-piece type can be used depending on implant placement and distance from adjacent teeth.

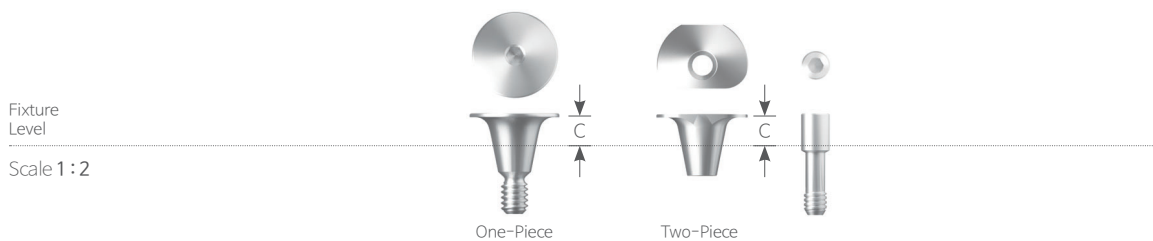



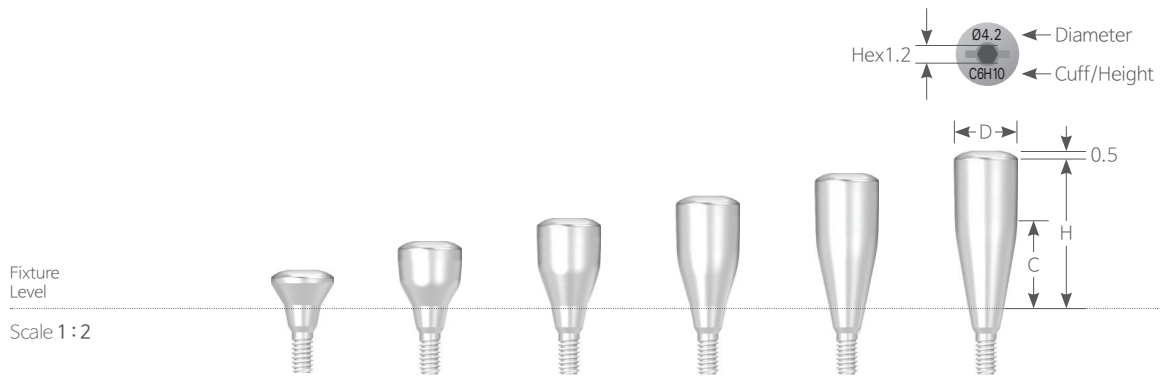

R		Unit mm Scale 1 : 1.25		
Fixture Size	Regular			
Type	One - Piece	Two - Piece		
Cuff 1.5	BFC 6565S	BFC 8080S	BFC 7060S	BFC 8055S
3	BFC 6565L	BFC 8080L	BFC 7060L	BFC 8055L

Healing Abutment

- Uses 1.2 Hex Driver
- Uses 0.5 Slot Driver
- Tightening Torque : 5~8Ncm



N Hex 1.2		Unit mm Scale 1 : 1.25			
Fixture Size	Narrow				
	→ Ø4.1 ←	→ Ø4.2 ←	→ Ø4.6 ←	→ Ø4.7 ←	
					
Height 2	UNSHA 4020	-	UNSHA 4520	-	
4	-	UNSHA 4024	-	UNSHA 4524	
5.5	-	UNSHA 4035	-	UNSHA 4535	
7	-	UNSHA 4047	-	UNSHA 4547	
8.5	-	UNSHA 4058	-	UNSHA 4558	
10	-	UNSHA 4060	-	UNSHA 4560	

Healing Abutment

- ▶ Used for small diameter abutment like Ball abutment
- ▶ Used if the fixture is deeply placed
- Uses 1.2 Hex Driver
- Uses 0.5 Slot Driver
- Tightening Torque : 5~8Ncm

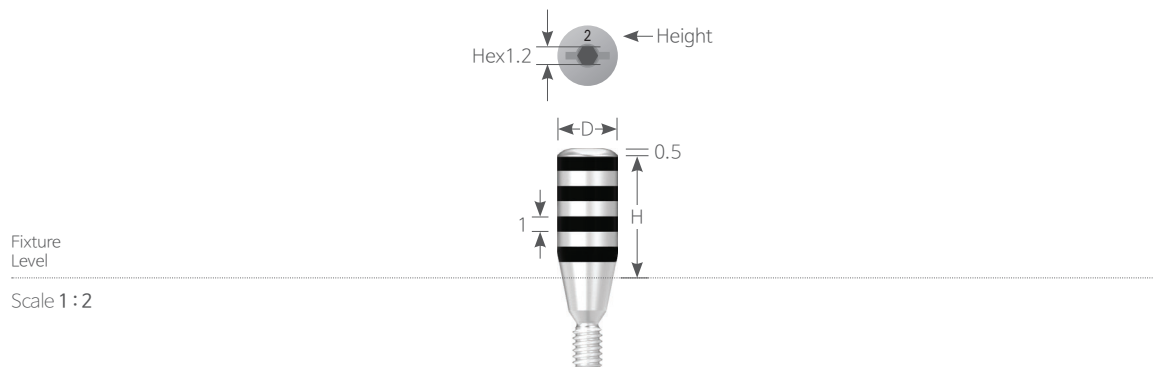

R	W	D	Ø4.0	Hex 1.2	Unit mm Scale 1:1.25
Fixture Size	Regular · Wide				
Height	2	4	6	8	



Healing Abutment

- Uses 1.2 Hex Driver
- Uses 0.5 Slot Driver
- Tightening Torque : 5~8Ncm

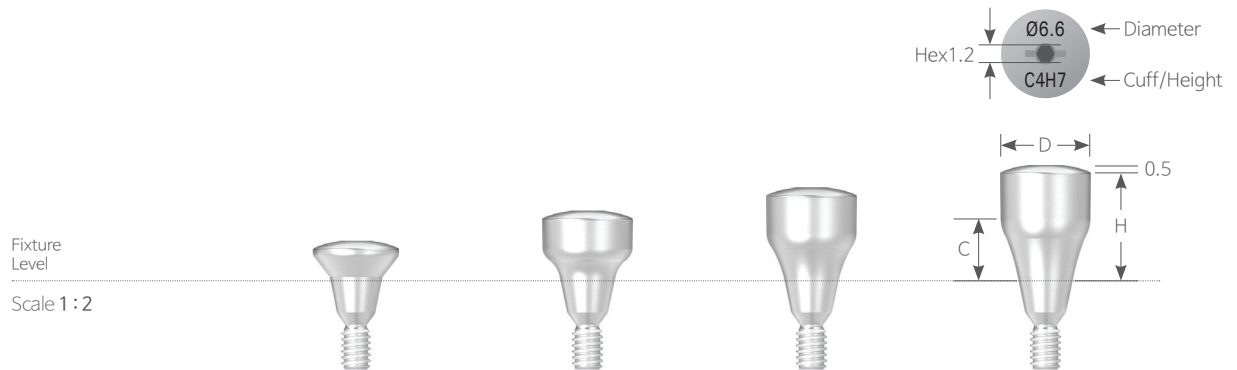

R W Hex 1.2 Unit mm | Scale 1 : 1.25

Fixture Size Regular · Wide



Height 2 Cuff 2	SSHA 4520	SSHA 5520	SSHA 6520	SSHA 7520
Height 4 Cuff 2	SSHA 4524	SSHA 5524	SSHA 6524	SSHA 7524
Height 5.5 Cuff 3	SSHA 4535	SSHA 5535	SSHA 6535	SSHA 7535
Height 7 Cuff 4	SSHA 4547	SSHA 5547	SSHA 6547	SSHA 7547

Healing Abutment

► Used for making the desired emergence profile.

- Caution
 - ① Connect the screw using 1.2 hex driver and hand-tighten (5~8Ncm)
 - ② Organized by diameter and height, the healing abutments can be selected according to the needs and requirements of a particular clinical case.
 - Gum Extension to secure an emergency profile in the posterior region, or components for minimizing inflammation response due to gingival compression during custom abutment production.
 - ※ When connecting the cover screw and healing abutment, the screw can be separated easily by applying antibiotics functioning as lubricant. (Antibiotics: Minocline, Periocline, etc.)
- Uses 1.2 Hex Driver
- Uses 0.5 Slot Driver
- Tightening Torque : 5~8Ncm

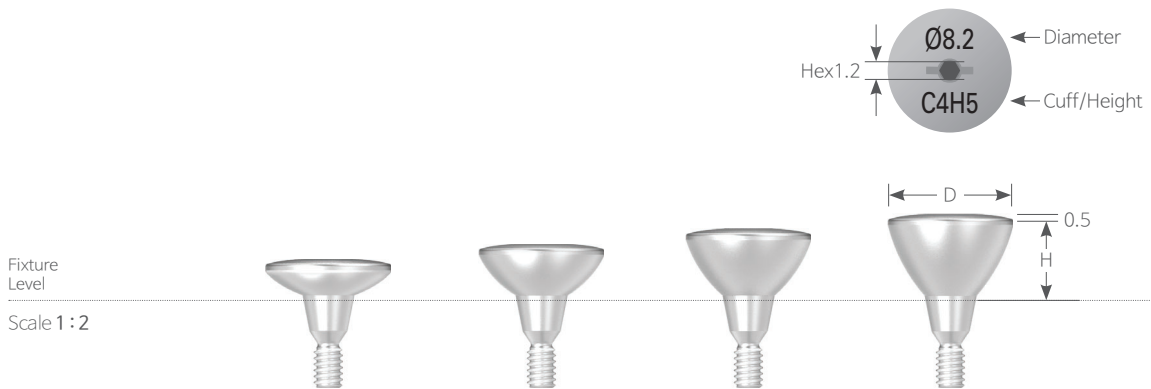

R W Hex 1.2 Unit mm | Scale 1 : 1.25

Fixture Size **Regular · Wide**



Height 2	SSHA 8212	SSHA 9212
3	SSHA 8223	SSHA 9223
4	SSHA 8234	SSHA 9234
5	SSHA 8245	SSHA 9245

Cement / Screw – Retained Restorations

Temporary / Cemented / Angled / UCLA Abutment

Fixture - **N R W**

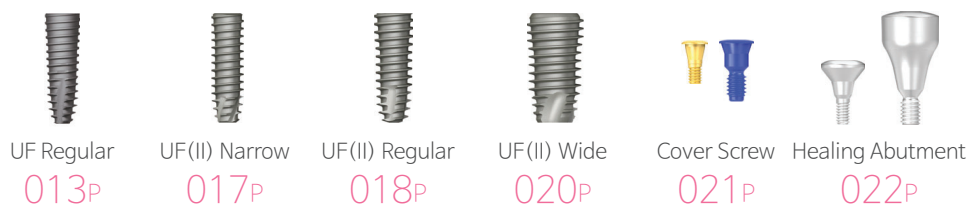
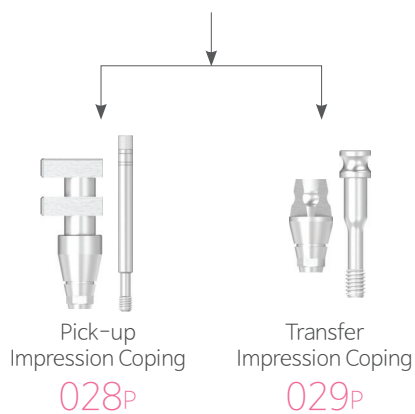
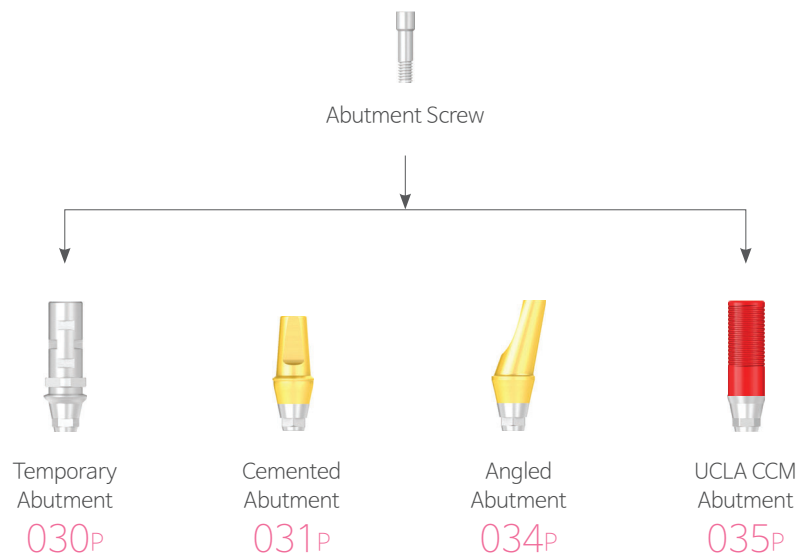

Cement / Screw – Retained Restorations

Mill / UCLA Abutment

Fixture - **R** **W**

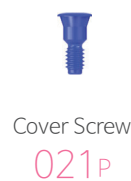
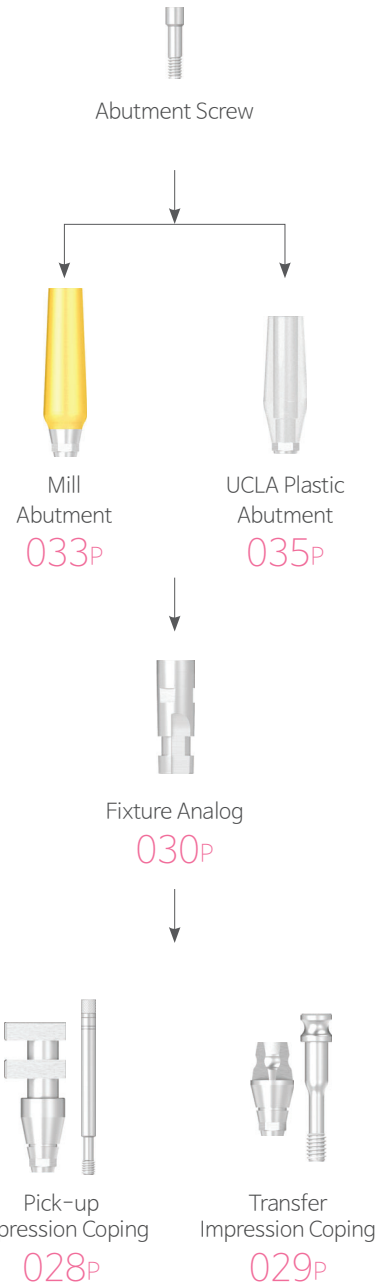

Abutment Components

Pick-up Impression Coping Hex Non-Hex

▶ Closed tray is used for pick-up type of impression taking.

- Uses 1.2 Hex Driver
- Packing Unit : Pick-up Impression Coping + Guide Pin

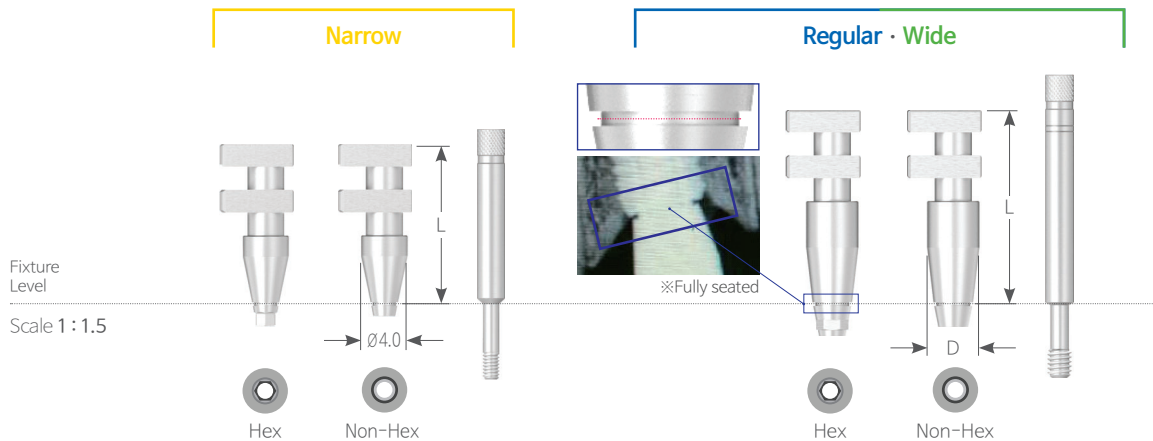

		N R W Hex						Unit mm
Fixture Size	Narrow		Regular · Wide					
Diameter	Ø4.0	Guide Pin	Ø4.0	Ø4.5	Ø5.5	Ø6.5	Guide Pin	
Length 09	-	-	SSPI 4009H	SSPI 4509H	SSPI 5509H	SSPI 6509H	SSG 2021	
12	UNSPI 4012H	UNSSG 1422	-	-	-	-	-	
13	-	-	SSPI 4013H	SSPI 4513H	SSPI 5513H	SSPI 6513H	SSG 2026	
14	UNSPI 4014H	UNSSG 1422	-	-	-	-	-	
16	UNSPI 4016H	UNSSG 1425	-	-	-	-	-	
17	-	-	SSPI 4017H	SSPI 4517H	SSPI 5517H	SSPI 6517H	SSG 2329	
19	-	-	SSPI 4019H	SSPI 4519H	SSPI 5519H	SSPI 6519H	SSG 2329	

		N R W Non-Hex						Unit mm
Fixture Size	Narrow		Regular · Wide					
Diameter	Ø4.0	Guide Pin	Ø4.0	Ø4.5	Ø5.5	Ø6.5	Guide Pin	
Length 09	-	-	SSPI 4009N	SSPI 4509N	SSPI 5509N	SSPI 6509N	SSG 2021	
12	UNSPI 4012N	UNSSG 1422	-	-	-	-	-	
13	-	-	SSPI 4013N	SSPI 4513N	SSPI 5513N	SSPI 6513N	SSG 2026	
14	UNSPI 4014N	UNSSG 1422	-	-	-	-	-	
16	UNSPI 4016N	UNSSG 1425	-	-	-	-	-	
17	-	-	SSPI 4017N	SSPI 4517N	SSPI 5517N	SSPI 6517N	SSG 2329	
19	-	-	SSPI 4019N	SSPI 4519N	SSPI 5519N	SSPI 6519N	SSG 2329	

Abutment Components

Transfer Impression Coping

Hex Non-Hex

▶ Open tray is used for transfer type of impression taking.

- Triple sided structure increases quality.
- Uses 1.2 Hex Driver
- Hex type is two-piece structure and Non-Hex type is one-piece structure.
- Packing Unit : Transfer Impression Coping + Coping Screw (Hex)
Transfer Impression Coping (Non-Hex)

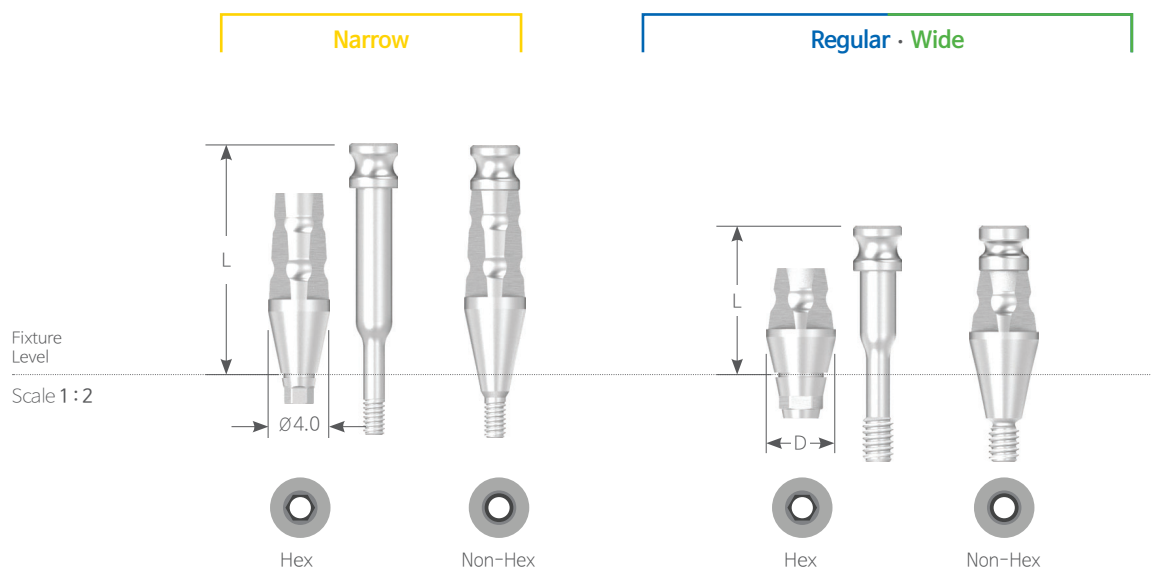

		N R W Hex							Unit mm
Fixture Size	Narrow		Regular · Wide						
Diameter	Ø4.0	Screw	Ø4.0	Ø4.5	Ø5.5	Screw	Ø6.5	Screw	
Length 10	-	-	SSTI 4010H	SSTI 4510H	SSTI 5510H	SSTI 4015S	SSTI 6510H	SSTI 6515S	
13	UNSTI 4013H	UNSTI 4013S	-	-	-	-	-	-	
15	UNSTI 4015H	UNSTI 4015S	SSTI 4015H	SSTI 4515H	SSTI 5515H	SSTI 4020S	SSTI 6515H	SSTI 6520S	
17	UNSTI 4017H	UNSTI 4017S	-	-	-	-	-	-	

		N R W Non-Hex					Unit mm
Fixture Size	Narrow		Regular · Wide				
Diameter	Ø4.0		Ø4.0	Ø4.5	Ø5.5	Ø6.5	
Length 10	-		SSTI 4010N	SSTI 4510N	SSTI 5510N	SSTI 6510N	
13	UNSTI 4013N		-	-	-	-	
15	UNSTI 4015N		SSTI 4015N	SSTI 4515N	SSTI 5515N	SSTI 6515N	
17	UNSTI 4017N		-	-	-	-	

Abutment Components

Fixture Analog

► Replicates implant for the fabrication of prosthetics on the working model.

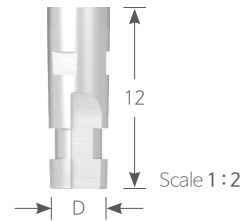

N R W Length 12

Unit:mm | Scale 1 : 1.25

Fixture Size	Narrow	Regular · Wide
Diameter	Ø3.0	Ø4.0



UNSFA 3012



SSFA 4012

Temporary Abutment Hex Non-Hex

► Used when temporary prosthesis is made

- Hex / Non-Hex Type
- Uses 1.2 Hex Driver
- Packing Unit : Abutment + Abutment Screw
- Tightening Torque : **N** 20Ncm, **R W** 30~35Ncm

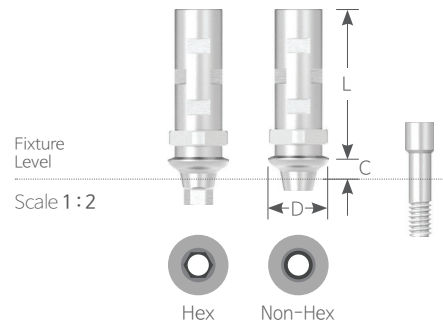

N R W Length 10

Unit:mm | Scale 1 : 1.25

Fixture Size	Narrow		Regular · Wide	
Diameter	Ø4.0		Ø4.5	
Type	Hex	Non-Hex	Hex	Non-Hex



Cuff 1 | UNSFA 4010H [H]



UNSTA 4010N [H]



SSTA 4510H [H]



SSTA 4510N [H]

3 | UNSTA 4030H [H]

UNSTA 4030N [H]

SSTA 4530H [H]

SSTA 4530N [H]

Abut. Screw | UNSAS 1407H [H]

UNSAS 1407H [H]

SSC 2008H

SSC 2008H

Cemented Abutment

Hex

Non-Hex

► For cement retained prosthesis

- Gold colored gingival area for esthetic purpose
- Uses 1.2 Hex Driver
- Compatible with Solid Abutment Impression Cap
- Packing Unit : Abutment + Abutment Screw (**N** UNSAS 1407H, **R W** Ø4.5 – SSC 2008SH / Ø5.5~Ø7.5 – SSC 2008H)
- Tightening Torque : **N** 20Ncm, **R W** 30~35Ncm

N R W Hex	Unit mm Scale 1 : 1.25				
Fixture Size	Narrow	Regular · Wide			
Diameter	Ø4.0	Ø4.5	Ø5.5	Ø6.5	Ø7.5



Length 4

Cuff 1	-	SSCA 45104H(II)[H]	SSCA 55104H(II)[H]	SSCA 65104H(II)[H]	SSCA 75104H(II)[H]
2	-	SSCA 45204H(II)[H]	SSCA 55204H(II)[H]	SSCA 65204H(II)[H]	SSCA 75204H(II)[H]
3	-	SSCA 45304H(II)[H]	SSCA 55304H(II)[H]	SSCA 65304H(II)[H]	SSCA 75304H(II)[H]
4	-	SSCA 45404H(II)[H]	SSCA 55404H(II)[H]	SSCA 65404H(II)[H]	SSCA 75404H(II)[H]
5	-	SSCA 45504H(II)[H]	SSCA 55504H(II)[H]	SSCA 65504H(II)[H]	SSCA 75504H(II)[H]
Screw	-	SSC 2008YH	SSC 2008H	SSC 2008H	SSC 2008H

Length 5.5

Cuff 1	UNSCA 40105H[H]	SSCA 45105H(II)[H]	SSCA 55105H(II)[H]	SSCA 65105H(II)[H]	SSCA 75105H(II)[H]
2	UNSCA 40205H[H]	SSCA 45205H(II)[H]	SSCA 55205H(II)[H]	SSCA 65205H(II)[H]	SSCA 75205H(II)[H]
3	UNSCA 40305H[H]	SSCA 45305H(II)[H]	SSCA 55305H(II)[H]	SSCA 65305H(II)[H]	SSCA 75305H(II)[H]
4	UNSCA 40405H[H]	SSCA 45405H(II)[H]	SSCA 55405H(II)[H]	SSCA 65405H(II)[H]	SSCA 75405H(II)[H]
5	UNSCA 40505H[H]	SSCA 45505H(II)[H]	SSCA 55505H(II)[H]	SSCA 65505H(II)[H]	SSCA 75505H(II)[H]
6	UNSCA 40605H[H]	-	-	-	-
7	UNSCA 40705H[H]	-	-	-	-
Screw	UNSCA 1407H	SSC 2008YH	SSC 2008H	SSC 2008H	SSC 2008H

Length 7

Cuff 1	UNSCA 40107H[H]	SSCA 45107H(II)[H]	SSCA 55107H(II)[H]	SSCA 65107H(II)[H]	SSCA 75107H(II)[H]
2	UNSCA 40207H[H]	SSCA 45207H(II)[H]	SSCA 55207H(II)[H]	SSCA 65207H(II)[H]	SSCA 75207H(II)[H]
3	UNSCA 40307H[H]	SSCA 45307H(II)[H]	SSCA 55307H(II)[H]	SSCA 65307H(II)[H]	SSCA 75307H(II)[H]
4	UNSCA 40407H[H]	SSCA 45407H(II)[H]	SSCA 55407H(II)[H]	SSCA 65407H(II)[H]	SSCA 75407H(II)[H]
5	UNSCA 40507H[H]	SSCA 45507H(II)[H]	SSCA 55507H(II)[H]	SSCA 65507H(II)[H]	SSCA 75507H(II)[H]
6	UNSCA 40607H[H]	-	-	-	-
7	UNSCA 40707H[H]	-	-	-	-
Screw	UNSCA 1407H	SSC 2008YH	SSC 2008H	SSC 2008H	SSC 2008H

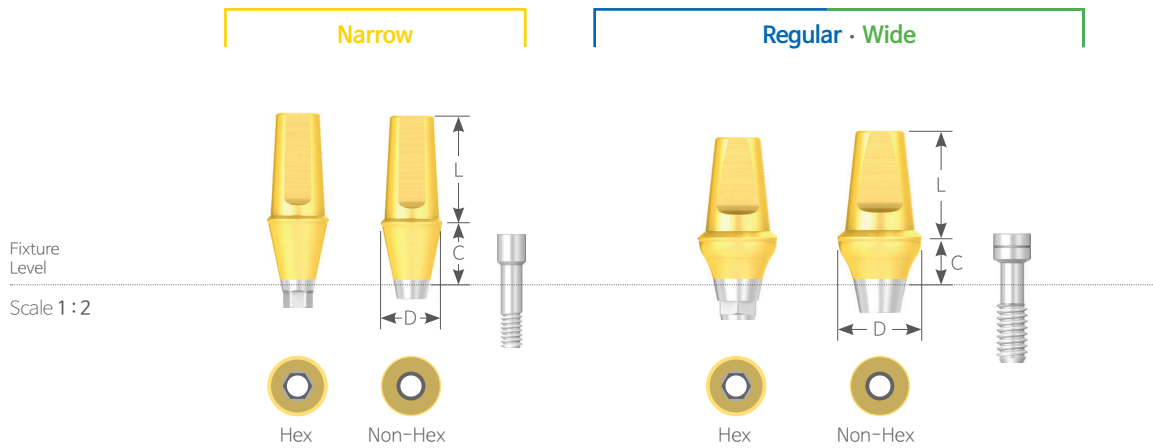

N R W Non-Hex

Unit mm | Scale 1 : 1.25

Fixture Size	Narrow	Regular · Wide			
Diameter	Ø4.0	Ø4.5	Ø5.5	Ø6.5	Ø7.5

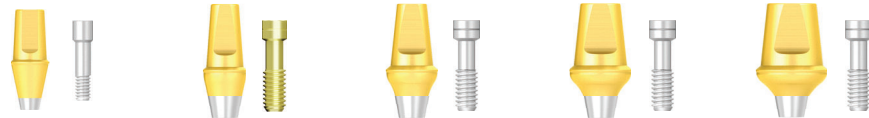

Length 4

Cuff 1	-	SSCA 45104N (II)[H]	SSCA 55104N (II)[H]	SSCA 65104N (II)[H]	SSCA 75104N (II)[H]
2	-	SSCA 45204N (II)[H]	SSCA 55204N (II)[H]	SSCA 65204N (II)[H]	SSCA 75204N (II)[H]
3	-	SSCA 45304N (II)[H]	SSCA 55304N (II)[H]	SSCA 65304N (II)[H]	SSCA 75304N (II)[H]
4	-	SSCA 45404N (II)[H]	SSCA 55404N (II)[H]	SSCA 65404N (II)[H]	SSCA 75404N (II)[H]
5	-	SSCA 45504N (II)[H]	SSCA 55504N (II)[H]	SSCA 65504N (II)[H]	SSCA 75504N (II)[H]
Screw	-	SSC 2008YH	SSC 2008H	SSC 2008H	SSC 2008H

Length 5.5

Cuff 1	UNSCA 40105N [H]	SSCA 45105N (II)[H]	SSCA 55105N (II)[H]	SSCA 65105N (II)[H]	SSCA 75105N (II)[H]
2	UNSCA 40205N [H]	SSCA 45205N (II)[H]	SSCA 55205N (II)[H]	SSCA 65205N (II)[H]	SSCA 75205N (II)[H]
3	UNSCA 40305N [H]	SSCA 45305N (II)[H]	SSCA 55305N (II)[H]	SSCA 65305N (II)[H]	SSCA 75305N (II)[H]
4	UNSCA 40405N [H]	SSCA 45405N (II)[H]	SSCA 55405N (II)[H]	SSCA 65405N (II)[H]	SSCA 75405N (II)[H]
5	UNSCA 40505N [H]	SSCA 45505N (II)[H]	SSCA 55505N (II)[H]	SSCA 65505N (II)[H]	SSCA 75505N (II)[H]
6	UNSCA 40605N [H]	-	-	-	-
7	UNSCA 40705N [H]	-	-	-	-
Screw	UNSAS 1407H	SSC 2008YH	SSC 2008H	SSC 2008H	SSC 2008H

Length 7

Cuff 1	UNSCA 40107N [H]	SSCA 45107N (II)[H]	SSCA 55107N (II)[H]	SSCA 65107N (II)[H]	SSCA 75107N (II)[H]
2	UNSCA 40207N [H]	SSCA 45207N (II)[H]	SSCA 55207N (II)[H]	SSCA 65207N (II)[H]	SSCA 75207N (II)[H]
3	UNSCA 40307N [H]	SSCA 45307N (II)[H]	SSCA 55307N (II)[H]	SSCA 65307N (II)[H]	SSCA 75307N (II)[H]
4	UNSCA 40407N [H]	SSCA 45407N (II)[H]	SSCA 55407N (II)[H]	SSCA 65407N (II)[H]	SSCA 75407N (II)[H]
5	UNSCA 40507N [H]	SSCA 45507N (II)[H]	SSCA 55507N (II)[H]	SSCA 65507N (II)[H]	SSCA 75507N (II)[H]
6	UNSCA 40607N [H]	-	-	-	-
7	UNSCA 40707N [H]	-	-	-	-
Screw	UNSAS 1407H	SSC 2008YH	SSC 2008H	SSC 2008H	SSC 2008H

Mill Abutment Hex Non-Hex

► Used when high customization in abutment path and prosthetic margins are needed.

- Abutment of cement retained type that uses dental cement to fix prosthesis in place
- Uses 1.2 Hex Driver
- Packing Unit : Abutment + Abutment Screw (SSC 2008H)
- Tightening Torque : 30~35Ncm

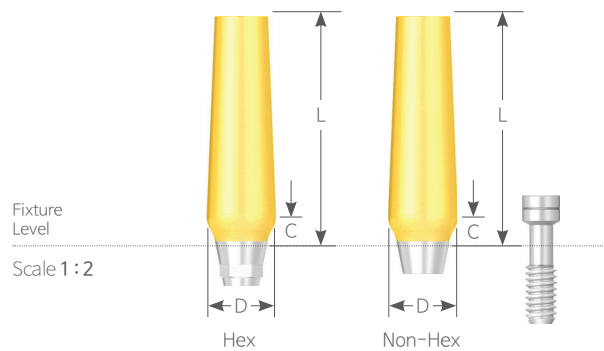

R **W** Hex Length 15

Unit mm | Scale 1 : 1.25

Fixture Size	Regular · Wide				
Diameter	Ø4.0	Ø4.5	Ø5.5	Ø6.5	Ø7.5
Cuff	1.5	2	2.5	3	3



SSMA 4015H [H] SSMA 4520H [H] SSMA 5525H [H] SSMA 6530H [H] SSMA 7530H [H]

R **W** Non-Hex Length 15

Unit mm | Scale 1 : 1.25

Fixture Size	Regular · Wide				
Diameter	Ø4.0	Ø4.5	Ø5.5	Ø6.5	Ø7.5
Cuff	1.5	2	2.5	3	3



SSMA 4015N [H] SSMA 4520N [H] SSMA 5525N [H] SSMA 6530N [H] SSMA 7530N [H]

Angled Abutment Hex Non-Hex

► Used to modify the fixture's path mainly used for anterior region.

- Depending on the angle slope, it is categorized into 15° and 25° Angled Abutment
- Availability of A type and B type of hex part overcomes the limitation of direction of the abutment
- Gold colored gingival area for esthetic purpose
- Uses 1.2 Hex Driver
- Packing Unit : Abutment + Abutment Screw (N UNSAS 1407H, R W SSC 2008H)
- Tightening Torque : N 20Ncm, R W 30~35Ncm

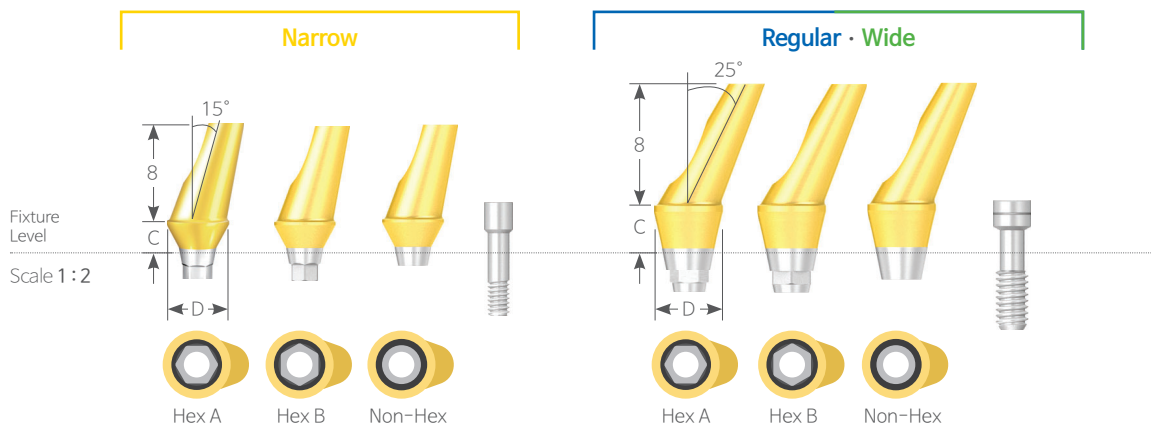

N R W Hex A Length 8

Fixture Size	Narrow	Regular · Wide			
Diameter	Ø4.0	Ø4.5		Ø5.5	
Angle	15°	15°	25°	15°	25°
Cuff 1.5	-	SSAA 451515AH [H]	SSAA 451525AH [H]	SSAA 551515AH [H]	SSAA 551525AH [H]
2.0	UNSA A 402015AH [H]	SSAA 452015AH [H]	SSAA 452025AH [H]	SSAA 552015AH [H]	SSAA 552025AH [H]
3.0	-	SSAA 453015AH [H]	SSAA 453025AH [H]	SSAA 553015AH [H]	SSAA 553025AH [H]
4.0	UNSA A 404015AH [H]	SSAA 454015AH [H]	SSAA 454025AH [H]	SSAA 554015AH [H]	SSAA 554025AH [H]
5.0	-	SSAA 455015AH [H]	SSAA 455025AH [H]	SSAA 555015AH [H]	SSAA 555025AH [H]
4.0	UNSA A 404015AH [H]	SSAA 454015AH [H]	SSAA 454025AH [H]	SSAA 554015AH [H]	SSAA 554025AH [H]
Screw	UNSA S 1407H	SSC 2008H	SSC 2008H	SSC 2008H	SSC 2008H

N R W Hex B Length 8

Fixture Size	Narrow	Regular · Wide			
Cuff 1.5	-	SSAA 451515BH [H]	SSAA 451525BH [H]	SSAA 551515BH [H]	SSAA 551525BH [H]
2.0	UNSA A 402015BH [H]	SSAA 452015BH [H]	SSAA 452025BH [H]	SSAA 552015BH [H]	SSAA 552025BH [H]
3.0	-	SSAA 453015BH [H]	SSAA 453025BH [H]	SSAA 553015BH [H]	SSAA 553025BH [H]
4.0	UNSA A 404015BH [H]	SSAA 454015BH [H]	SSAA 454025BH [H]	SSAA 554015BH [H]	SSAA 554025BH [H]
5.0	-	SSAA 455015BH [H]	SSAA 455025BH [H]	SSAA 555015BH [H]	SSAA 555025BH [H]
Screw	UNSA S 1407H	SSC 2008H	SSC 2008H	SSC 2008H	SSC 2008H

N R W Non-Hex Length 8

Fixture Size	Narrow	Regular · Wide			
Cuff 1.5	-	SSAA 451515N [H]	SSAA 451525N [H]	SSAA 551515N [H]	SSAA 551525N [H]
2.0	UNSA A 402015N [H]	SSAA 452015N [H]	SSAA 452025N [H]	SSAA 552015N [H]	SSAA 552025N [H]
3.0	-	SSAA 453015N [H]	SSAA 453025N [H]	SSAA 553015N [H]	SSAA 553025N [H]
4.0	UNSA A 404015N [H]	SSAA 454015N [H]	SSAA 454025N [H]	SSAA 554015N [H]	SSAA 554025N [H]
5.0	-	SSAA 455015N [H]	SSAA 455025N [H]	SSAA 555015N [H]	SSAA 555025N [H]
Screw	UNSA S 1407H	SSC 2008H	SSC 2008H	SSC 2008H	SSC 2008H

UCLA Abutment

UCLA CCM Abutment Hex Non-Hex

- After the customization, **non-precious metal alloy will be casted only.**
- Uses 1.2 Hex Driver
- Packing Unit : Abutment + Abutment Screw (N UNSAS 1407H, R W SSC 2008H)
- Tightening Torque : 30~35Ncm

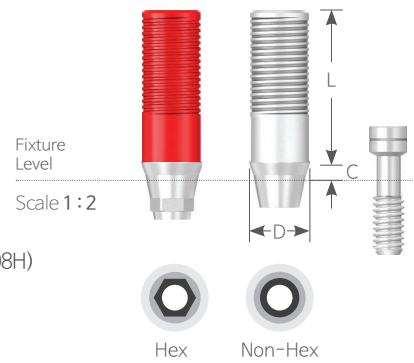

N R W Length 10

Unit mm | Scale 1 : 1.25

Fixture Size	Narrow		Regular · Wide			
Diameter	Ø4.0	Ø4.0	Ø4.0	Ø4.0	Ø4.5	Ø4.5
Hex	Hex	Non-Hex	Hex	Non-Hex	Hex	Non-Hex



Cuff 1	UNSCCA 4010H [H]	UNSCCA 4010N [H]	CCSS 4010H [H]	CCSS 4010N [H]	CCSS 4510H [H]	CCSS 4510N [H]
3	UNSCCA 4030H [H]	UNSCCA 4030N [H]	-	-	CCSS 4530H [H]	CCSS 4530N [H]

UCLA Plastic Abutment Hex Non-Hex

- After the customization, **non-precious metal alloy will be casted only.**
- Uses 1.2 Hex Driver
- Packing Unit : Abutment + Abutment Screw(Hex) (SSC2008H)
- Tightening Torque : Tightening smoothly before casting,
30~35Ncm after casting

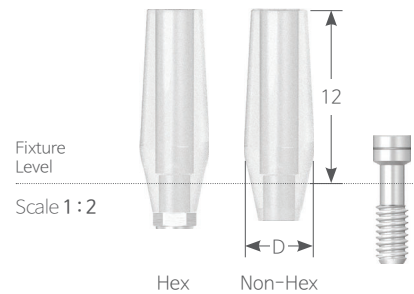

R W Length 12

Unit mm | Scale 1 : 1.25

Fixture Size	Regular · Wide			
Diameter	Ø4.5	Ø4.5	Ø5.5	Ø5.5
Type	Hex	Non-Hex	Hex	Non-Hex



SSPA 4512H [H] SSPA 4512N [H] SSPA 5512H [H] SSPA 5512N [H]

Cement – Retained Restorations

Solid Abutment

Fixture - **N** **R** **W**



Plastic Coping

039P



Solid Abutment Analog

039P



Impression Cap

038P



Solid Abutment

037P



Protect Cap

038P



UF Regular

013P



UF(II) Narrow

017P



UF(II) Regular

018P



UF(II) Wide

020P



Cover Screw

021P



Healing Abutment

022P

Solid Abutment

► Abutment of cement retained type that uses dental cement to fix prosthesis in place

- Abutment and screw are in one-piece structure.
- Taking impression at abutment level.
- Gold colored gingival area for esthetic purpose
- Uses 1.2 Hex Driver / Solid Abutment Driver
- Packing Unit : Abutment + Protect Cap
- Tightening Torque : **N** 20Ncm, **R W** 30~35Ncm

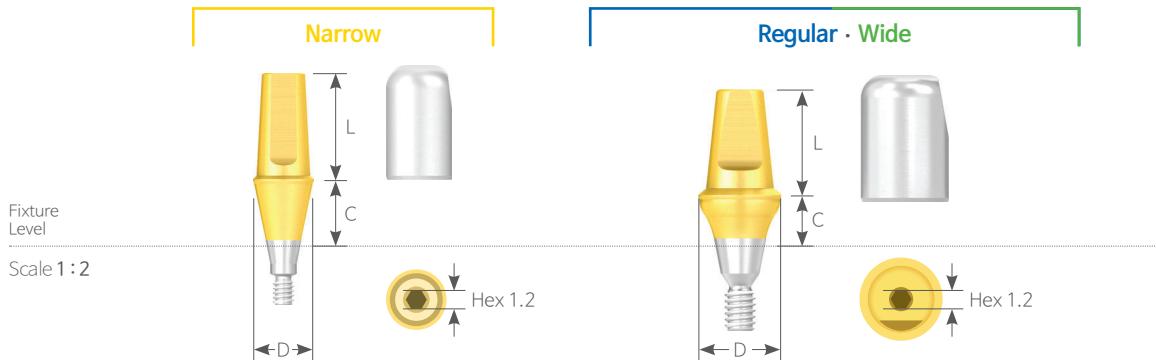

N R W

Unit mm | Scale 1 : 1.25

Fixture Size	Narrow	Regular - Wide			
Diameter	Ø4.0	Ø4.5	Ø5.5	Ø6.5	Ø7.5



Length 4 Cuff 1	1	-	SSSA 45104	SSSA 55104	SSSA 65104	SSSA 75104
	2	-	SSSA 45204	SSSA 55204	SSSA 65204	SSSA 75204
	3	-	SSSA 45304	SSSA 55304	SSSA 65304	SSSA 75304
	4	-	SSSA 45404	SSSA 55404	SSSA 65404	SSSA 75404
	5	-	SSSA 45504	SSSA 55504	SSSA 65504	SSSA 75504

Length 5.5 Cuff 1	1	UNSSA 40105	SSSA 45105	SSSA 55105	SSSA 65105	SSSA 75105
	2	UNSSA 40205	SSSA 45205	SSSA 55205	SSSA 65205	SSSA 75205
	3	UNSSA 40305	SSSA 45305	SSSA 55305	SSSA 65305	SSSA 75305
	4	UNSSA 40405	SSSA 45405	SSSA 55405	SSSA 65405	SSSA 75405
	5	UNSSA 40505	SSSA 45505	SSSA 55505	SSSA 65505	SSSA 75505
	6	UNSSA 40605	-	-	-	-
	7	UNSSA 40705	-	-	-	-

Length 7 Cuff 1	1	UNSSA 40107	SSSA 45107	SSSA 55107	SSSA 65107	SSSA 75107
	2	UNSSA 40207	SSSA 45207	SSSA 55207	SSSA 65207	SSSA 75207
	3	UNSSA 40307	SSSA 45307	SSSA 55307	SSSA 65307	SSSA 75307
	4	UNSSA 40407	SSSA 45407	SSSA 55407	SSSA 65407	SSSA 75407
	5	UNSSA 40507	SSSA 45507	SSSA 55507	SSSA 65507	SSSA 75507
	6	UNSSA 40607	-	-	-	-
	7	UNSSA 40707	-	-	-	-

Solid Abutment Components

Protect Cap

► Used to protect abutment in the patient's mouth and minimize discomfort for the patient.

- Can be applied to substructure of temporary prosthesis.
- Convenient locking mechanism.



	N	R	W		
Fixture Size	Narrow		Regular · Wide		
Abut. Diameter	Ø4.0	Ø4.5	Ø5.5	Ø6.5	Ø7.5
Abut. Length 4	-	SSAC 4504	SSAC 5504	SSAC 6504	SSAC 7504
5.5	UNSAI 4005	SSAC 4505	SSAC 5505	SSAC 6505	SSAC 7505
7	UNSAI 4007	SSAC 4507	SSAC 5507	SSAC 6507	SSAC 7507

Unit mm | Scale 1:2

Impression Cap

► Used for taking impression of Solid Abutment.

- Different coloring provides easy identification for abutment diameter.
- Convenient locking mechanism.

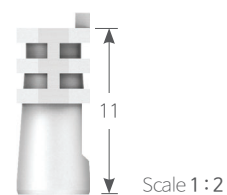

	N	R	W	Length 11		
Fixture Size	Narrow		Regular · Wide			
Abut. Diameter	Ø4.0	Ø4.5	Ø5.5	Ø6.5	Ø7.5	

Unit mm | Scale 1:1.25



UNSAI 4011



SSAI 4511



SSAI 5511



SSAI 6511



SSAI 7511

Solid Abutment Analog

- Solid Abutment is formed on working model.
- Different coloring provides easy identification for abutment diameter.



Scale 1 : 2

N R W

Unit mm | Scale 1 : 1.25

Fixture Size	Narrow	Regular · Wide			
Abut. Diameter	Ø4.0	Ø4.5	Ø5.5	Ø6.5	Ø7.5



Abut. Length 4	-	SSAA 4504	SSAA 5504	SSAA 6504	SSAA 7504
5.5	UNSSAA 4005	SSAA 4505	SSAA 5505	SSAA 6505	SSAA 7505
7	UNSSAA 4007	SSAA 4507	SSAA 5507	SSAA 6507	SSAA 7507

Plastic Coping

- ▶ Can be used as prosthesis' frame work by installing Solid Abutment Analog.
- Different coloring provides easy identification on types of case.

Narrow

Regular · Wide



Single



Bridge



Single



Bridge

N R W

Length 10

Unit mm | Scale 1 : 2

Fixture Size	Narrow	Regular · Wide			
Abut. Diameter	Ø4.0	Ø4.5	Ø5.5	Ø6.5	Ø7.5

● Single	UNSSAP 4010S	SSAP 4510S	SSAP 5510S	SSAP 6510S	SSAP 7510S
○ Bridge	UNSSAP 4010B	SSAP 4510B	SSAP 5510B	SSAP 6510B	SSAP 7510B

Cement / Screw – Retained Restorations

Octa Abutment

Fixture - R W

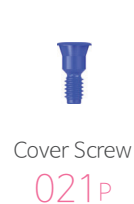
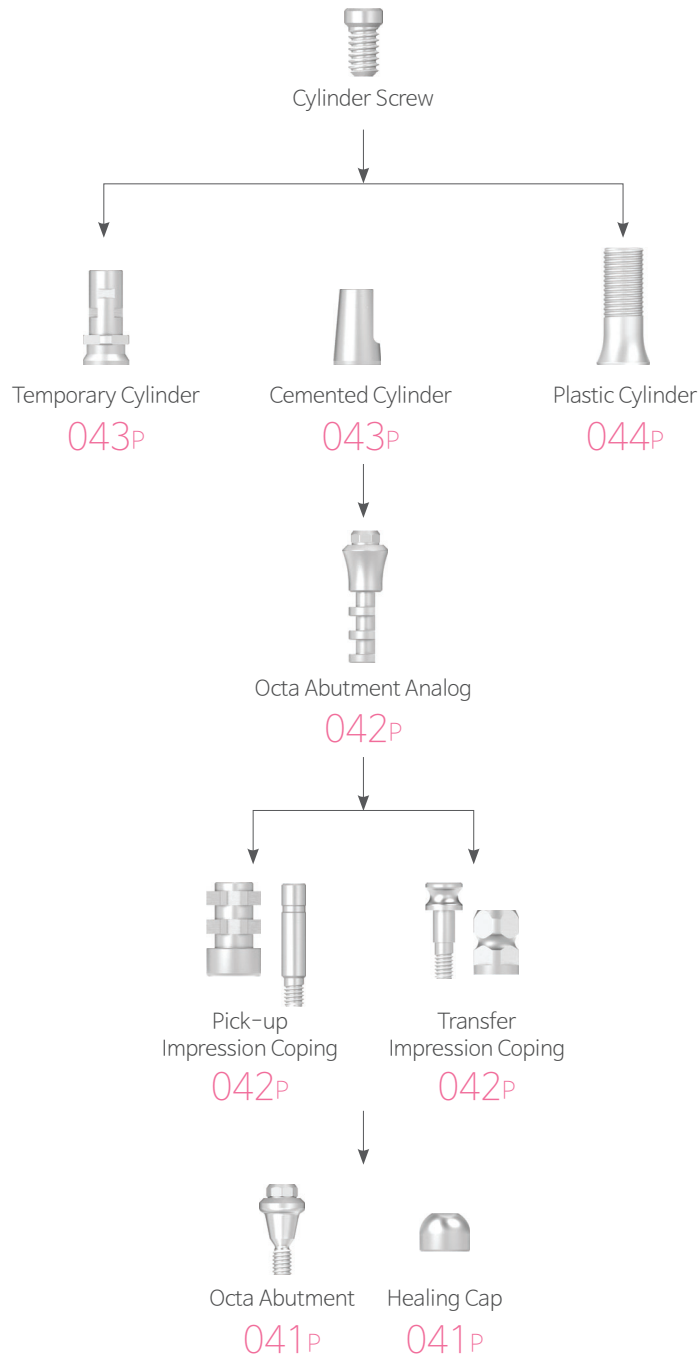

Octa Abutment

► Used to create screw retained prosthesis on poor path bridge case.

- Convert internal connection to external connection, and then use cylinder on it for prosthesis.
- Uses Octa Abutment Driver (HD 3006A-Short / HD 3012A-Long)
- Packing Unit : Octa Abutment + Abutment Holder (SSOAH 4020) (Convenient to install in patient's Mouth)
- Tightening Torque : 30~35Ncm

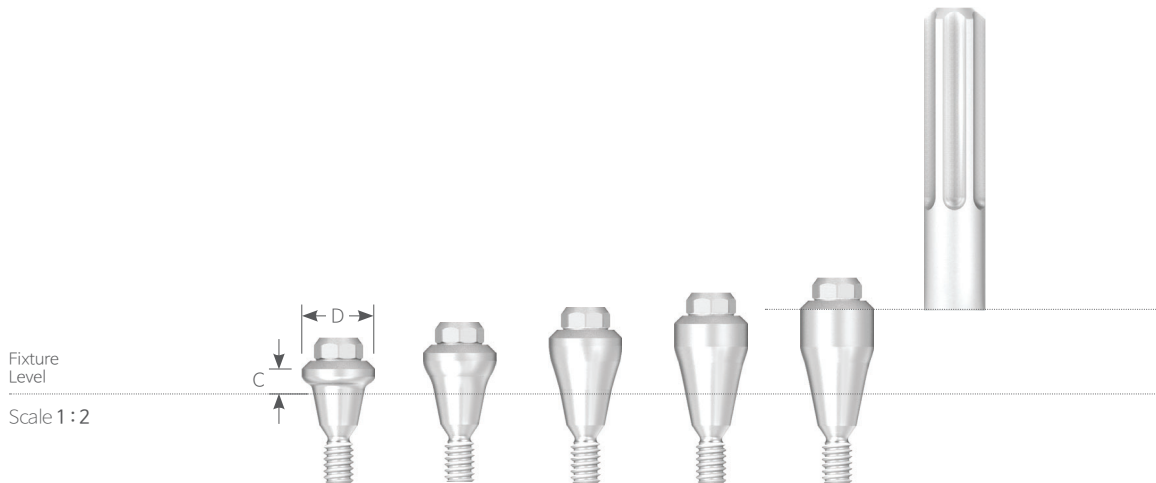

R W		Unit mm Scale 1:2		
Fixture Size	Regular · Wide			
Diameter	Ø4.8	Ø6.0	Ø6.5	
Cuff 1.5	SSOA 4815	SSOA 6015	SSOA 6515	
2.5	SSOA 4825	SSOA 6025	SSOA 6525	
3.5	SSOA 4835	SSOA 6035	SSOA 6535	
4.5	SSOA 4845	SSOA 6045	SSOA 6545	
5.5	SSOA 4855	SSOA 6055	SSOA 6555	

Healing Cap

► To protect Octa Abutment in oral, and minimize the discomfort for patient.

- Uses 1.2 Hex Driver
- Packing Unit : Healing Cap + Cylinder Screw (STI 2004H)
- Tightening Torque : 20Ncm



R W		Unit mm Scale 1:2		
Fixture Size	Regular · Wide			
Abut. Diameter	Ø4.8	Ø6.0	Ø6.5	
	HCI 48504[H]	HCI 60704[H]	HCI 65704[H]	

Octa Abutment Components

Pick-up Impression Coping Octa Non-Octa

- ▶ Open tray is used for pick-up type of impression taking.
- Asymmetry structure to minimize close interruption
- Uses 1.2 Hex Driver
- Packing Unit : Pick-up Impression Coping + Guide Pin (POI 2610)

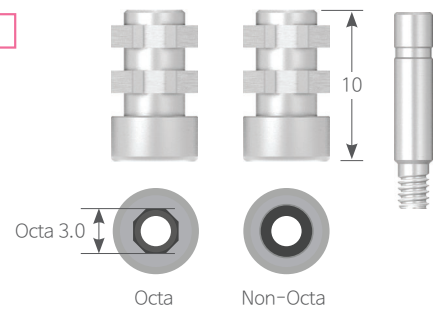

R W Length 10		Unit mm Scale 1:2		
Fixture Size	Regular · Wide			
Abut. Diameter	Ø4.8	Ø6.0	Ø6.5	
Octa	IPI 48610	IPI 60710	IPI 65710	
Non-Octa	IPI 48610N	IPI 60710N	IPI 65710N	

Transfer Impression Coping

- ▶ Closed tray is used for transfer type of impression taking.
- Double sided structure which elevates the quality
- Uses 1.2 Hex Driver
- Packing Unit : Transfer Impression Coping + Coping Screw (IOTI 48010S)

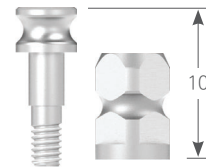

R W Length 10		Unit mm Scale 1:2		
Fixture Size	Regular · Wide			
Abut. Diameter	Ø4.8	Ø6.0	Ø6.5	
	IOTI 48010	IOTI 60010	IOTI 65010	

Octa Abutment Analog

- ▶ Replicates Octa Abutment for fabrication of prosthetics on the working model.

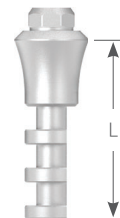

R W		Unit mm Scale 1:2		
Fixture Size	Regular · Wide			
Abut. Diameter	Ø4.8	Ø6.0	Ø6.5	
Length 10	-	RCI 60014	-	
12	RCI 48014	-	RCI 65014	

Temporary Cylinder Octa Non-Octa

- Uses 1.2 Hex Driver
- Packing Unit : Temporary Cylinder + Cylinder Screw (STI 2004H)
- Tightening Torque : 20Ncm

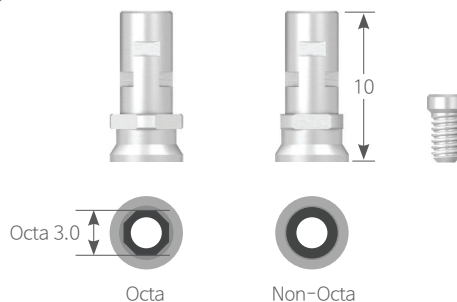

R W Length 10		Unit mm Scale 1 : 2		
Fixture Size	Regular · Wide			
Abut. Diameter	Ø4.8	Ø6.0	Ø6.5	
Octa	ITC 48010 [H]	ITC 60010 [H]	ITC 65010 [H]	
Non-Octa	ITC 48010N [H]	ITC 60010N [H]	ITC 65010N [H]	

Cemented Cylinder Octa Non-Octa

- Uses 1.2 Hex Driver
- Packing Unit : Cemented Cylinder + Cylinder Screw (Hex) (STI 2004H)
- Tightening Torque : 20Ncm

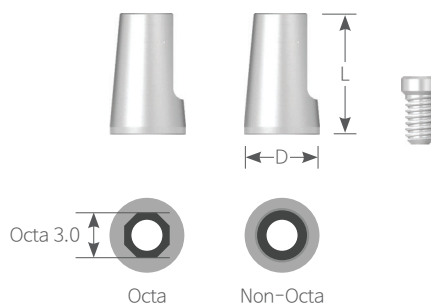

R W		Unit mm Scale 1 : 2			
Fixture Size	Regular · Wide				
Abut. Diameter	Ø4.8	Ø4.8	Ø6.0	Ø6.5	
Cylinder Diameter	Ø5.0	Ø5.8	Ø6.4	Ø6.9	
Length	8	8	9	9	
Octa	ICC 48508 [H]	ICC 48588 [H]	ICC 60649 [H]	ICC 65309 [H]	
Non-Octa	ICC 48508N [H]	ICC 48588N [H]	ICC 60649N [H]	ICC 65309N [H]	

Octa Abutment Components

Plastic Cylinder Octa Non-Octa

- After the customization, **non-precious metal alloy will be casted only.**
- Uses 1.2 Hex Driver
- Packing Unit : Plastic Cylinder + Cylinder Screw(STI 2004H)
- Tightening Torque : 20Ncm

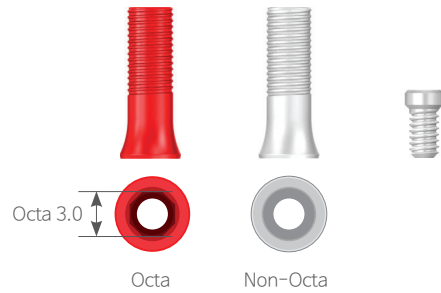

		Unit mm Scale 1:2		
		Regular · Wide		
Fixture Size		Ø4.8	Ø6.0	Ø6.5
Octa ●	API 48514	API 60714	API 65714	
Non-Octa ○	API 48514N	API 60714N	API 65714N	

Surgical Tool

Abutment Driver

- Only uses Octa Abutment

● Sold separately

Unit mm | Scale 1:1

		K	
Type		Short	Long
Code		HD 3006A	HD 3012A



Overdenture Restorations

Ball Abutment : O-Ring

Fixture - **R** **W**

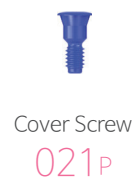
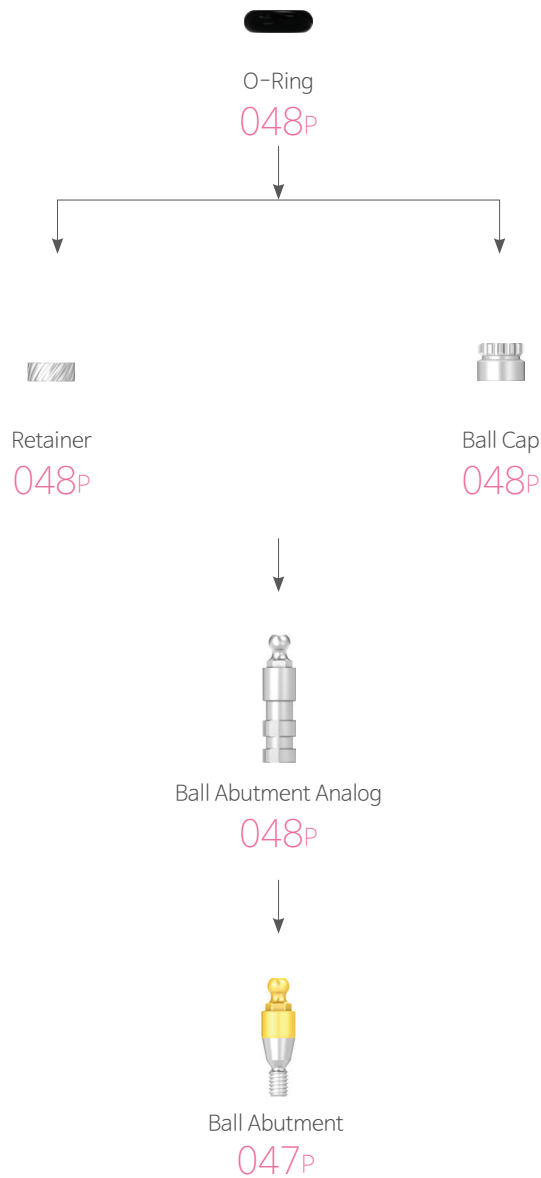

Overdenture Restorations

Ball Abutment : OT Cap / Locator

Fixture - **N R W**



Stainless Steel Housing

049P



OT Cap

049P



Ball Abutment Analog

048P



Ball Abutment

047P



Denture Cap

052P



Male

051P



Locator

050P



UF Regular

013P



UF(II) Narrow

017P



UF(II) Regular

018P



UF(II) Wide

020P



Cover Screw

021P



Healing Abutment

022P

Ball Abutment

► Used to create overdenture for edentulous patient.

- Gold colored gingival area for esthetic purpose
- Path recovery to the maximum of 20°
- Uses Ball Abutment Driver (HD 2406A, HD 2412A)
- Packing Unit : Ball Abutment + Abutment Holder (BAH 3520 | Abutment Holder is convenient to install in patient's mouth) + O-Ring (OR 04500)
- Tightening Torque : **N** 20Ncm, **R W** 30~35Ncm

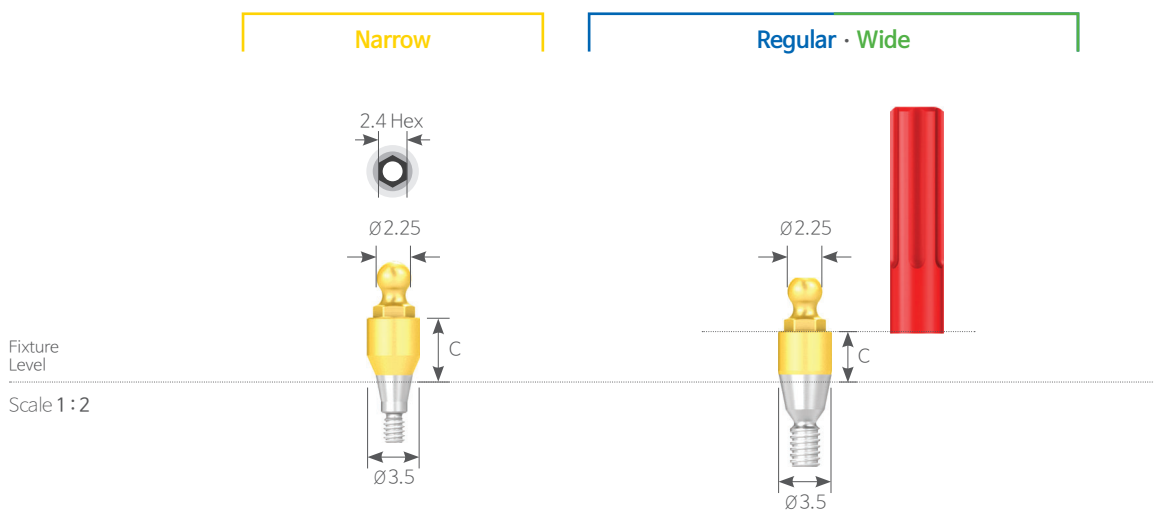

	N	R	W	
Fixture Size	Narrow		Regular · Wide	
Diameter	Ø3.5		Ø3.5	
Cuff 1	UNSBA 3510		SSBA 3510	
2	UNSBA 3520		SSBA 3520	
3	UNSBA 3530		SSBA 3530	
4	UNSBA 3540		SSBA 3540	
5	UNSBA 3550		SSBA 3550	
6	UNSBA 3560		SSBA 3560	
7	UNSBA 3570		-	

Unit mm

Ball Abutment Components

Ball Abutment Analog

► Provides anchor point for ball abutment on working model.



N R W Length 10

Unit mm | Scale 1:2

Fixture Size	Narrow	Regular · Wide
Abut. Diameter	Ø3.5	Ø3.5

UNSBAA 3510

SABA 3510

Retainer

- Advantageous when occlusal distance is low compare to Ball Cap.
- Packing Unit : Retainer + O-Ring (OR 0450B + OR 04500)

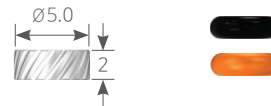

N R W D Ø5.0 Length 2

Unit mm | Scale 1:2

Fixture Size	Narrow · Regular · Wide
--------------	--------------------------------

RT 0502

Ball Cap

- Outstanding consistency and clip-on
- Packing Unit : Ball Cap + O-Ring (OR 0450B + OR 04500)

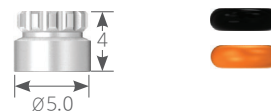

N R W D Ø5.0 Length 4

Unit mm | Scale 1:2

Fixture Size	Narrow · Regular · Wide
--------------	--------------------------------

BC 5004

O-Ring

- Black : For dental lab use
- Orange : For clinic use (over 6Ncm)
- Packing Unit : O-Ring 1 Piece

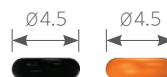

N R W D Ø4.5

Unit mm | Scale 1:2

Fixture Size	Narrow · Regular · Wide
--------------	--------------------------------

OR 0450B

OR 04500

Color

● Black

● Orange

OT Cap Orange

- Excellent retention is obtained with broader contact area compared to o-ring.
- Packing Unit : 6 Piece
- Caution) There is no separate cap for dental lab.
Replace the cap after making the denture.

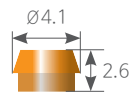

N R W D Ø4.1 Length 2.6

Unit mm | Scale 1 : 2

Fixture Size

Narrow · Regular · Wide

049PCNDR8

Stainless Steel Housing

- The new stainless steel housing decrease the size that can provide better stability and retention with resin.
- Packing Unit : 2 Pieces

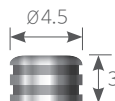

N R W D Ø4.5 Length 3

Unit mm | Scale 1 : 2

Fixture Size

Narrow · Regular · Wide

041CAN

Insertion Tool For Caps

- ▶ Used for insertion the cap in the stainless housing.
- Possible to use both tip in a normal and micro situation.
- Packing Unit : Handle + Tip



N R W

Fixture Size

Narrow · Regular · Wide

085IAC

Remover Tool For Caps

- ▶ Used for removing the cap from the stainless housing
- Possible to use in both normal and micro situation with one tool.



N R W

Fixture Size

Narrow · Regular · Wide

091EC

Locator

- Upgraded from the conventional method used (O-Ring System, Bar Type System, etc.) by connecting a locator abutment to the fixture and used by connecting to / separating from male part connected to the denture

Locator Abutment

- Uses Locator Driver
- Tightening Torque : **N** 20Ncm, **R W** 30~35Ncm

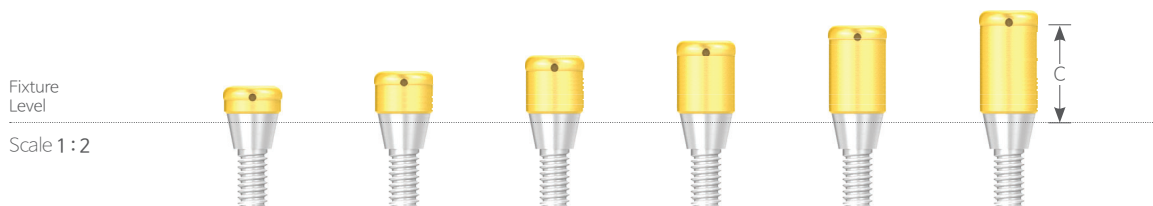



	N	R	W	
Fixture Size	Narrow		Regular · Wide	
Cuff 1	02961		02967	
2	02962		02968	
3	02963		02969	
4	02964		02970	
5	02965		02971	
6	02966		02972	

Unit mm

Locator Components





Replacement Male

- Path recovery to the maximum of 20°
- Packing Unit : 1ea

	N	R	W	
Retention		1.5 LBS	3 LBS	5 LBS
				
		LOC 8529	LOC 8527	LOC 8524
Intensity		Weak	Intermediate	Strong

Extended Replacement Male

- Path recovery to the maximum of 20° ~ 40°
- Packing Unit : 1ea

	N	R	W		
Retention		0 LBS	1 LBS	2 LBS	4 LBS
					
		LOC 8558	LOC 8548	LOC 8915	LOC 8547
Intensity		Weak	Intermediate	Intermediate	Strong

Male Package

- Packing unit : 2set
 - Denture cap (LOC 8510) +
 - Black Processing Male (LOC 8515) +
 - Replacement Male (White, Pink, Blue) +
 - Block-Out Spacer (LOC 8514)
- Choose the Male of proper retention depends on the case
- Replace the Male using by Locator Core Tool



	N	R	W	
Type				2 Set
				08519-2

Locator Components

Denture cap

· Packing Unit : 1 ea



N **R** **W**

Fixture Size

Narrow · **Regular** · **Wide**

LOC 8510

Black Processing Male

· Use during process of prosthesis fabrication.

· Packing Unit : 1 ea



N **R** **W**

Fixture Size

Narrow · **Regular** · **Wide**

LOC 8515

Block-Out Spacer

· Use for sealing the space between Abutment and Denture cap.

· Packing Unit : 1 ea



N **R** **W**

Fixture Size

Narrow · **Regular** · **Wide**

LOC 8514

Locator

Locator Core Tool

- Used to connect and separate Replacement Male from Denture cap
- Divided into three pieces and can be used for Locator Abutment and hand drive.



N R W

Code

LOC 8393

Locator Square Drive Torque Wrench Driver

- Torque Driver for Locator Abutment

N R W

Unit mm | Scale 1 : 1

Code

LOC 8926

LOC 8927



Cement / Screw – Retained Restorations

Multiunit / Conical Abutment

Fixture - **N R W**

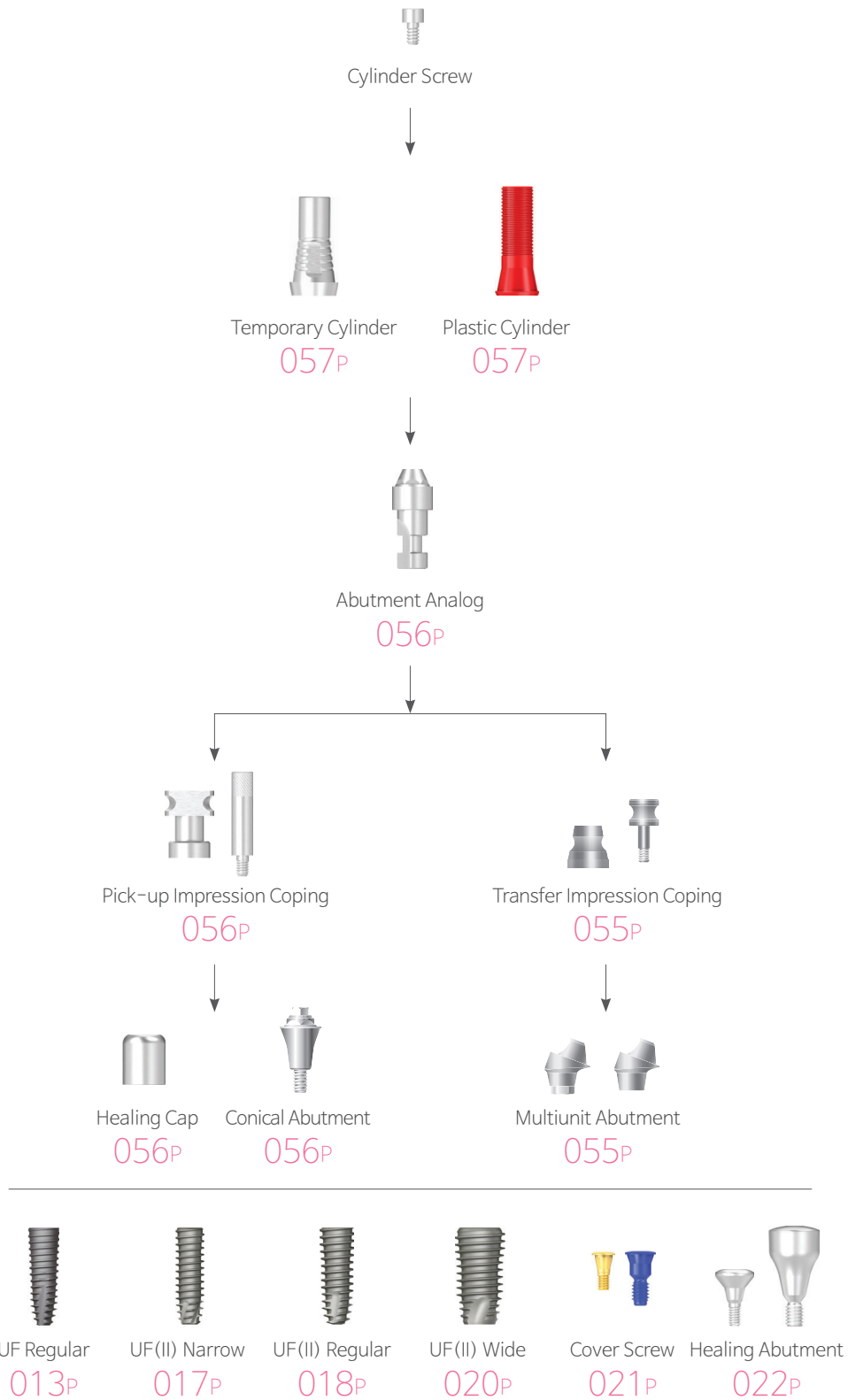

Multiunit Abutment

Hex Non-Hex

- Packing Unit : Abutment + Screw (MAS2006S) + Holder (MAH1425)
- Tightening Torque : **N** 20Ncm, **R W** 30Ncm

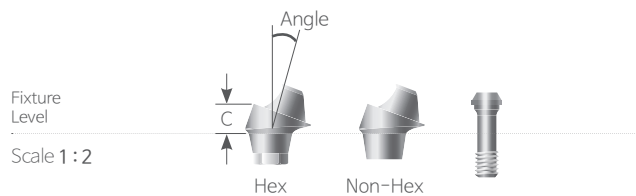

N R W Hex				Unit mm
Fixture Size	Narrow	Regular · Wide		
Angle	20°	20°	30°	
Cuff 2.5	-	UMA 482520H	-	
3	UNSMUA 483020H	UMA 483020H	UMA 483030H	
4	UNSMUA 484020H	UMA 484020H	UMA 484030H	
5	UNSMUA 485020H	UMA 485020H	UMA 485030H	

N R W Non-Hex			
Fixture Size	Narrow	Regular · Wide	
Angle	20°	20°	30°
Cuff 2.5	-	UMA 482520N	-
3	UNSMUA 483020N	UMA 483020N	UMA 483030N
4	UNSMUA 484020N	UMA 484020N	UMA 484030N
5	UNSMUA 485020N	UMA 485020N	UMA 485030N

Multiunit Screw Driver

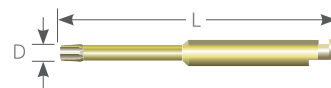

N R W D Ø1.4 Length 25		Unit mm Scale 1 : 1.25
Code	MSD 1425	

Transfer Impression Coping



N R W		Unit mm Scale 1 : 1.25
Code	ICC 4805 / ICCS 1407	

Conical Abutment

- Maintains screw and prosthetic aesthetics.
- For fabrication of prosthetic on cylinder after abutment has been placed.
- Up to 48° path angle
- Uses Ø2.0 Conical Abutment Driver (HD 2012A)
- Tightening Torque : 30Ncm

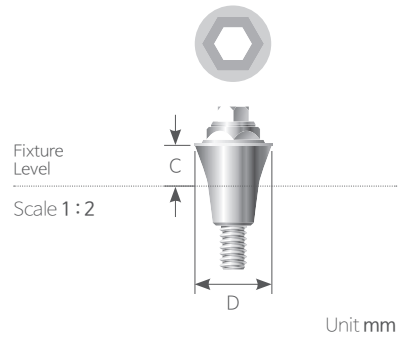

N R W D Ø4.8

Fixture Size	Narrow	Regular · Wide
Cuff 1	UNSKA 4801	UCA 4801
2	UNSKA 4802	UCA 4802
3	UNSKA 4803	UCA 4803

Healing Cap

- Protects the Conical Abutment and promotes patient healing.
- Uses 1.2 Hex Driver
- Tightening Torque : 20Ncm



N R W D Ø1.4 Length 4.5

Unit mm | Scale 1 : 2

Code	HCN 40504
------	-----------

Pick-up Impression Coping

- Create final impression of Conical Abutment on Impression Coping.
- For use with pick-up type closed trays.
- Packing Unit : Pick-up Impression Coping + Guide Pin

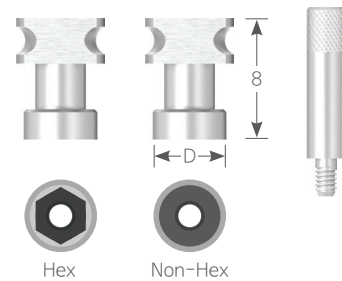

N R W D Ø4.8 Length 8

Unit mm | Scale 1 : 2

Type	Hex	Non Hex
	IPN 40508	IPN 40508N
Guide Pin	PCN 40310	PCN 40310S

Abutment Analog

- ▶ Replicates Conical Abutment/Multiunit Abutment for fabrication of prosthetics on the working model.

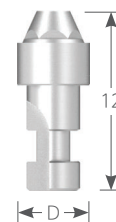

N R W D Ø4.8 Length 12

Unit mm | Scale 1 : 1.25

Code	RCN 40412
------	-----------

Multiunit / Conical Abutment Components

Temporary Cylinder Hex Non-Hex

- For fabricating temporary prosthetics on top of Conical Abutments.
- Simple customization & Minimizes restriction
- Uses 1.2 Hex Driver
- Packing Unit : Temporary Cylinder + Cylinder Screw (SHN 1403)
- Tightening Torque : 20Ncm

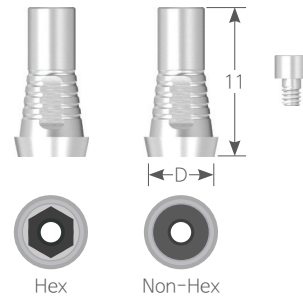

N R W D Ø5.4 Length 11 Unit mm | Scale 1 : 18

Type	Hex	Non Hex
	TCN 40511	TCN 40511N

Plastic Cylinder Hex Non-Hex

- Cast in premium gold alloy after customization.
- Uses 1.2 Hex Driver
- Packing Unit : Plastic Cylinder + Cylinder Screw (SHN 1403)
- Tightening Torque : 20Ncm

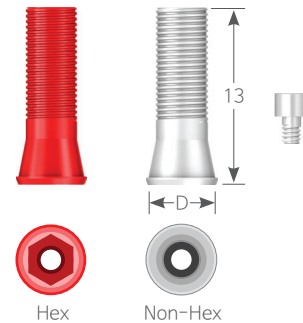

N R W D Ø5.0 Length 13 Unit mm | Scale 1 : 18

Type	Hex	Non Hex
	APN 40514S	APN 40514SN

Cylinder Screw

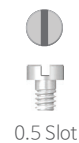

N R W Length 3 Unit mm | Scale 1 : 2

Code	SSN 1403

Conical Screw Driver



N R W Unit mm | Scale 1 : 1

Code	HD 2012A

Cement / Screw – Retained Restorations

Multiunit Abutment

Fixture - **R** **W**

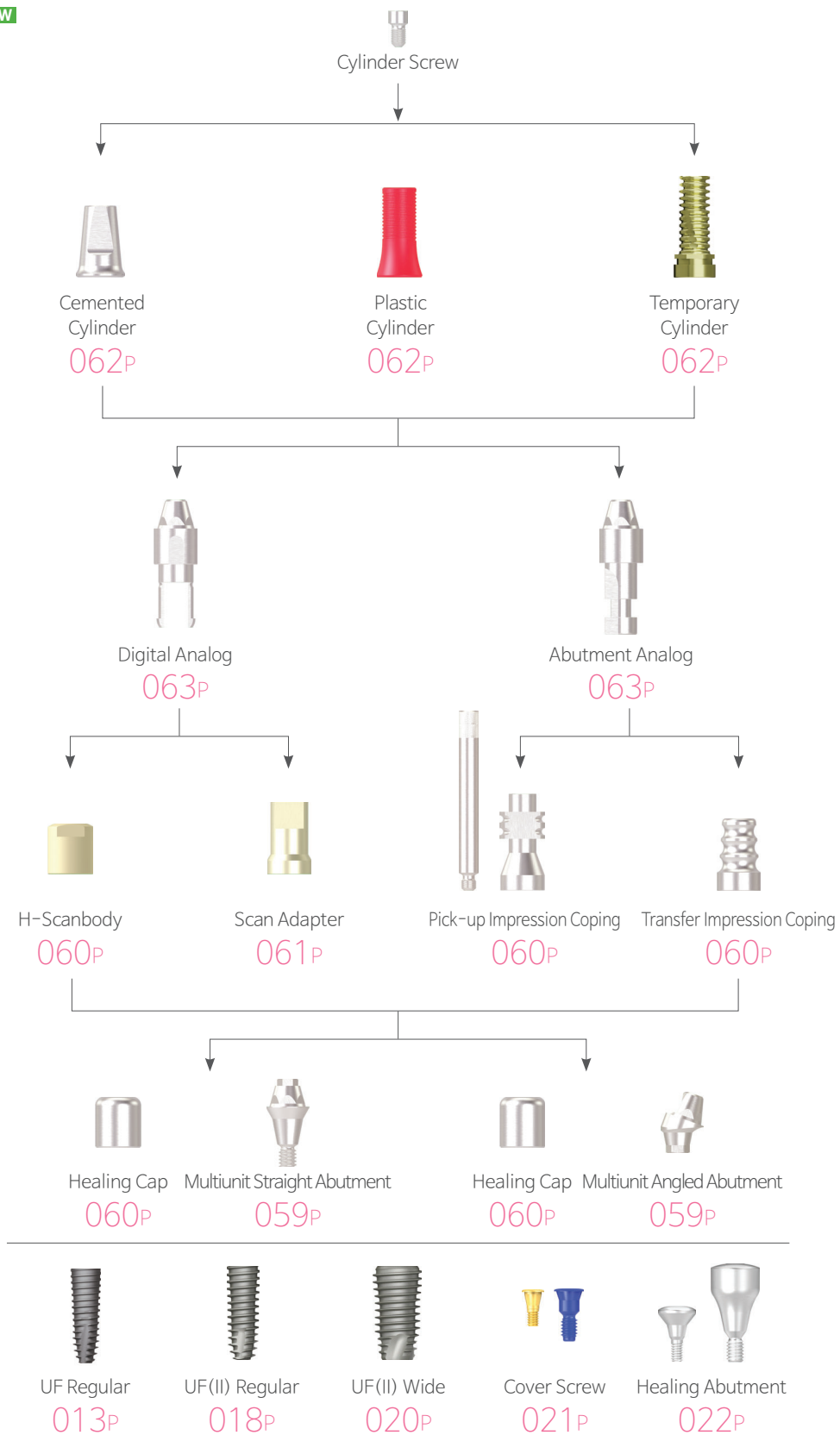

Multiunit Straight Abutment

► Use it to fabricate cement and screw-retained prosthesis in a bridge case with different path.

- Tightening Torque : 30Ncm
- Packing unit : Multiunit Straight Abutment + Holder (MSAH 4820)
- Use Ø2.0 Multiunit Straight Abutment Driver (HD 2012A (Same as Conical Abutment Driver))

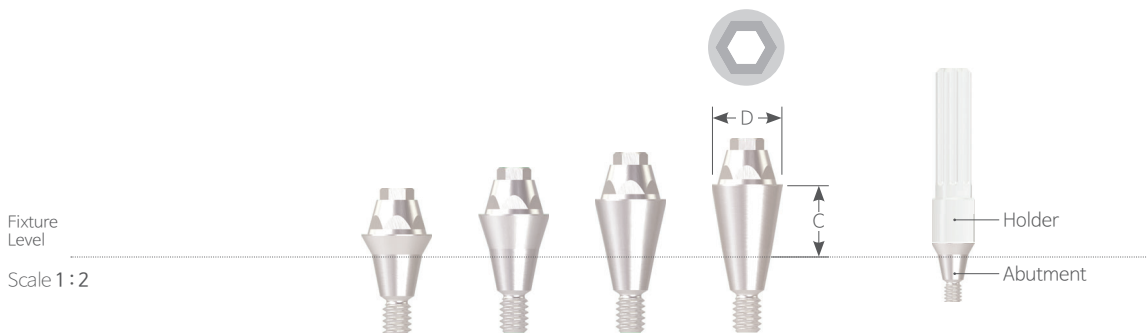

R W D Ø4.8		Unit mm			
Cuff		1.5	2.5	3.5	4.5
		MSA 4801	MSA 4802	MSA 4803	MSA 4804

Multiunit Angled Abutment

Hex Non-Hex

► Use it to fabricate cement and screw-retained prosthesis in a bridge case with different path.

- Multiunit Angled Abutment and Fixture (UFII Regular / Wide) are fastened with the Multiunit Angled Abutment Screw (MASC 2006).
- Multiunit Angled Abutment is path compensate Maximum up to 60°
- Tightening Torque : 30Ncm
- Packing unit : Multiunit Angled Abutment + Screw + Holder (MAH 1629)
- Use Multiunit Angled Abutment Driver (MHD 1215A (Ratchet) / MMD 1224 (Machine))

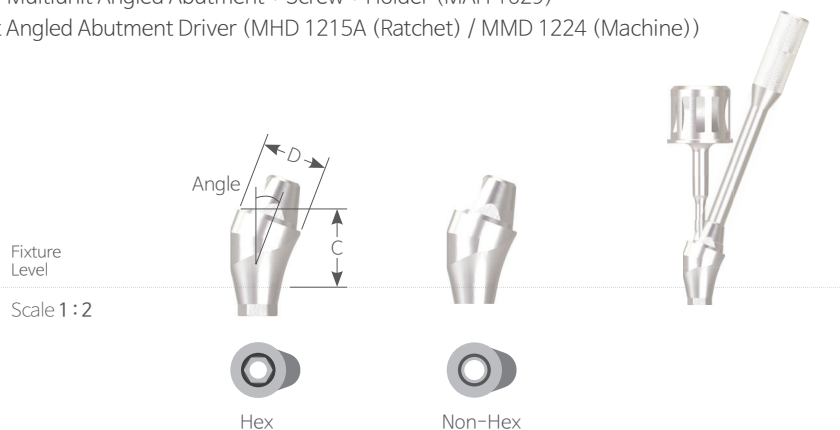

R W D Ø4.8		Unit mm			
Type		Hex		Non-Hex	
Angle		20°	30°	20°	30°
Cuff	2.5	MAA 482520H	-	MAA 482520N	-
	3.5	MAA 483520H	MAA 483530H	MAA 483520N	MAA 483530N
	4.5	MAA 484520H	MAA 484530H	MAA 484520N	MAA 484530N
	5.5	MAA 485520H	MAA 485530H	MAA 485520N	MAA 485530N
Screw		UNSAS 1407			

Multiunit Abutment Components

Healing Cap

- To protect Abutment and minimize the discomfort in the patient's mouth.
- Uses 1.2 Hex Driver
- Tightening Torque : 5~8Ncm

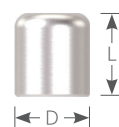

Unit mm | Scale 1:2

R W D Ø5.0 Length 5.5

Code	MHC 5005
------	----------

Pick-up Impression Coping

- Pick-up type Impression Coping to take an abutment level impression.
- Used with an open tray
- Only for Multiunit Abutment
- Uses 1.2 Hex Driver
- Packing Unit : Pick-up Impression Coping + Guide Pin (MGP 1615)
- Tightening Torque : 5~8Ncm

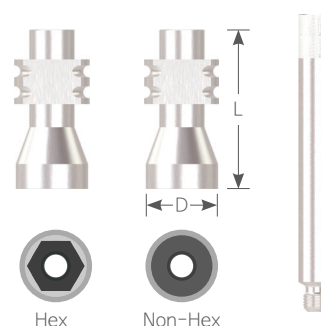

Unit mm | Scale 1:2

R W D Ø4.8 Length 11

Type	Hex	Non Hex
	MPI 4811H	MPI 4811N

Transfer Impression Coping

- Transfer type Impression Coping to take an abutment level impression.
- Used with Closed Tray
- Only for Multiunit Abutment
- Uses 1.2 Hex Driver
- Tightening Torque : 5~8Ncm

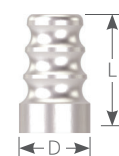

Unit mm | Scale 1:2

R W D Ø4.8 Length 8

Code	MTI 4808N
------	-----------

H-Scanbody

- Only use Multiunit Straight(MSA) / Multiunit Angled(MAA) Abutment
- Use for digital Impression taking
- Uses 1.2 Hex Driver
- Packing Unit : H-Scan body + Screw(MHSBSC 1603)
- Tightening Torque : 5~8Ncm

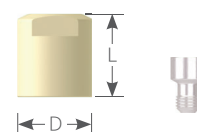

Unit mm | Scale 1:2

R W D Ø5.0 Length 5.6

Code	MHSB 5005H
------	------------

Scan Adapter

- Only use Multiunit Straight(MSA) / Multiunit Angled(MAA) Abutment
- Uses 1.2 Hex Driver
- Packing Unit : Scan Adapter + Screw (MCSC 1606)
- Tightening Torque : 5~8Ncm

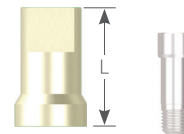

R W D Ø4.8 Length 8	Unit mm Scale 1:2
Code	MSCAN 4808H

Cylinder Protector

- Protect inner surface of cylinder while producing the denture from resin and etc.

R W D Ø4.8	Unit mm Scale 1:1.5	
Length	4.5	14.2
	MCP 4804	MCP 4814

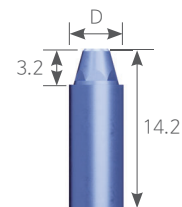
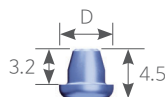

Multunit Abutment Components

Cemented Cylinder Hex Non-Hex

- Used to fabricate cement-retained prosthesis.
- Uses 1.2 Hex Driver
- Packing Unit : Cemented Cylinder + Screw (MSC 1604)
- Tightening Torque : 20Ncm

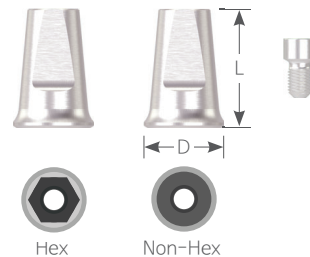

R **W** **D Ø5.4** Length 8

Unit mm | Scale 1:2

Type	Hex	Non Hex
	MCEM 5408H	MCEM 5408N

Plastic Cylinder Hex Non-Hex

- Used to fabricate prosthesis with casting with non-precious metal alloys.
- Color Type : Hex type(Red), Non-Hex type(White)
- Uses 1.2 Hex Driver
- Packing Unit : Plastic Cylinder + Screw(MSC 1604)
- Tightening Torque : 20Ncm



R **W** **D Ø5.0** Length 10

Unit mm | Scale 1:2

Type	Hex	Non Hex
	MPLA 5010H	MPLA 5010N

Temporary Cylinder Hex Non-Hex

- Used to fabricate temporary prosthesis.
- Uses 1.2 Hex Driver
- Packing Unit : Temporary Cylinder+ Screw(MSC 1604)
- Tightening Torque : 20Ncm

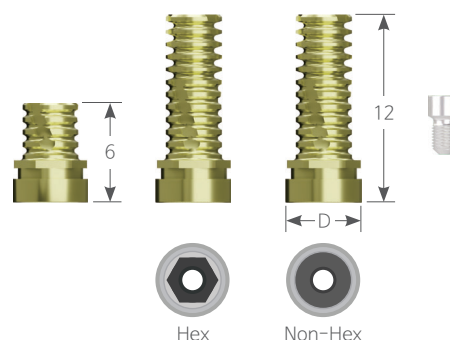

R **W** **D Ø5.4** Length 12

Unit mm | Scale 1:2

Type	Hex	Non-Hex
Length 6	MTEM 4806H	MTEM 4806N
Length 12	MTEM 4812H	MTEM 4812N

Cylinder Screw



R W Length 4

Unit mm | Scale 1 : 2

Code	MSC 1604
------	----------

Abutment Analog

· Replicates Multiunit Straight/Angled Abutment for fabrication of prosthetics on the working model.



R W D Ø4.8 Length 15

Unit mm | Scale 1 : 2

Code	MLA 4815H
------	-----------

Digital Analog

· Provides anchor point for Multiunit Abutment on 3D printed model.
 · Uses Digital Lab Analog Jig (MDAJ 00)

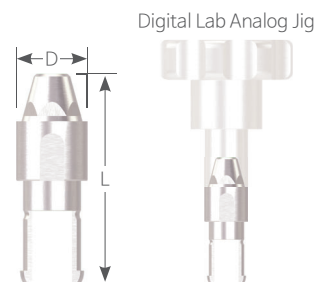

R W D Ø4.8 Length 14.2

Unit mm | Scale 1 : 2

Code	MDA 4813
------	----------

Surgical Tool

Screw Driver

· Only uses Multiunit Angled Abutment (ex : MAA 0000)

K Hex 1.2

● Sold separately
 Unit mm | Scale 1 : 1

Type	Machine	Ratchet
Code	MMD 1224	MHD 1215A



Digital Abutment

The library can be downloaded from the website.
 (<https://hq.dionavi.com/cad/cadlib.do>)

Digital abutment that is **better** than stock abutments and more **convenient** than customized abutments.

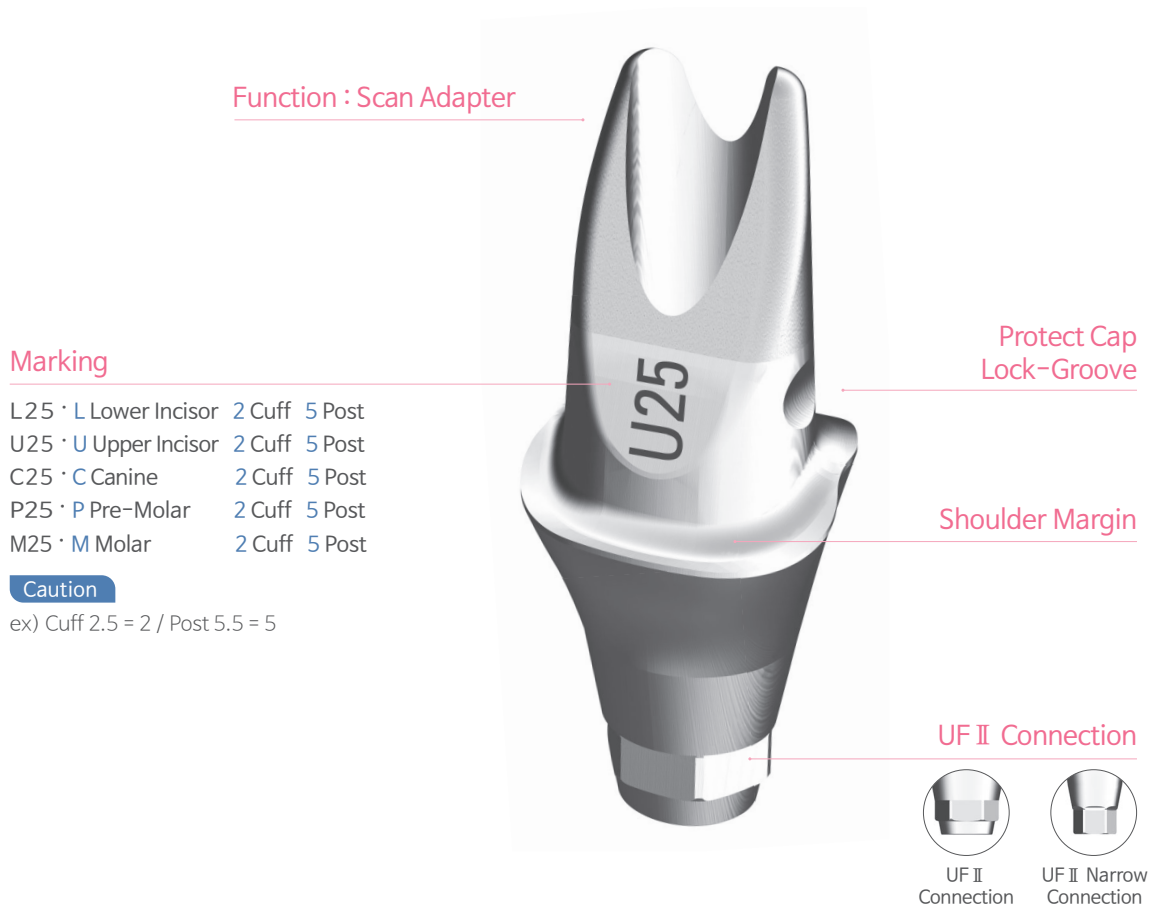

	Lower Incisor	Upper Incisor	Canine	Pre-Molar	Molar
Cross Section					
Cervical Margin Cross Section					
Facial Side	→	→	→	→	→
Connection	UF(II) Narrow	UF(II) Narrow /UF(II)	UF(II)	UF(II)	UF(II)
Cervical Margin Dimension (Mesiodistal x faciolingual)	5 X 5.2	6.1 X 5.7	5.3 X 6.3	5.8 X 6.8	7.3 X 7.8
Ratio (%)	70%	70% / 85%	85%	85%	85%

Lower Incisor

UFII Narrow Angled Abutment Hex Non-Hex

- Packing Unit : Abutment + Abutment Screw + Protect Cap
- Abutment Screw : UNSAS 1407H (Only compatible with the screw included)

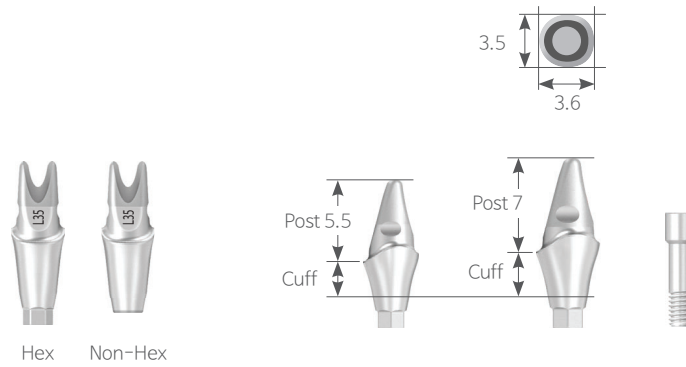

N Post 5.5					Unit mm Scale 1 : 1.25
Cuff	2.5	3.5	4.5	5.5	Protect Cap

Hex	DLN 2555H [C]	DLN 3555H [C]	DLN 4555H [C]	DLN 5555H [C]	DCLN 55
Non-Hex	DLN 2555N [C]	DLN 3555N [C]	DLN 4555N [C]	DLN 5555N [C]	DCLN 55
Marking	L 25	L 35	L 45	L 55	-

N Post 7.0					Unit mm Scale 1 : 1.25
Cuff	2.5	3.5	4.5	5.5	Protect Cap

Hex	DLN 2570H [C]	DLN 3570H [C]	DLN 4570H [C]	DLN 5570H [C]	DCLN 70
Non-Hex	DLN 2570N [C]	DLN 3570N [C]	DLN 4570N [C]	DLN 5570N [C]	DCLN 70
Marking	L 27	L 37	L 47	L 57	-

Upper Incisor

UFII Narrow Angled Abutment Hex Non-Hex

- Packing Unit : Abutment + Abutment Screw + Protect Cap
- Abutment Screw : UNSAS 1407H (Only compatible with the screw included)

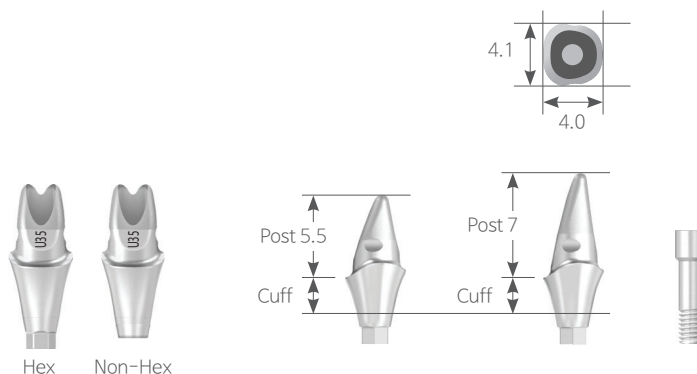

N Post 5.5

Unit mm | Scale 1 : 1.25

Cuff	2.5	3.5	4.5	5.5	Protect Cap
------	-----	-----	-----	-----	-------------



Hex	DUN 2555H [C]	DUN 3555H [C]	DUN 4555H [C]	DUN 5555H [C]	DCUN 55
Non-Hex	DUN 2555N [C]	DUN 3555N [C]	DUN 4555N [C]	DUN 5555N [C]	DCUN 55
Marking	U 25	U 35	U 45	U 55	-

N Post 7.0

Cuff	2.5	3.5	4.5	5.5	Protect Cap
------	-----	-----	-----	-----	-------------



Hex	DUN 2570H [C]	DUN 3570H [C]	DUN 4570H [C]	DUN 5570H [C]	DCUN 70
Non-Hex	DUN 2570N [C]	DUN 3570N [C]	DUN 4570N [C]	DUN 5570N [C]	DCUN 70
Marking	U 27	U 37	U 47	U 57	-

UFII Angled Abutment Hex Non-Hex

- Packing Unit : Abutment + Abutment Screw + Protect Cap
- Abutment Screw : DASC 2008H (Only compatible with the screw included)

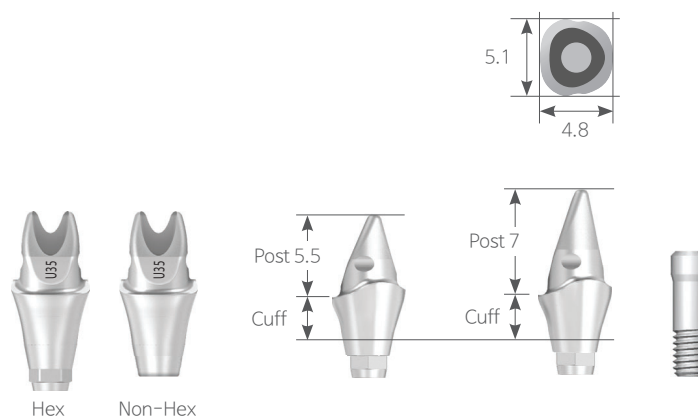

R Post 5.5

Unit mm | Scale 1 : 1.25

Cuff	2.5	3.5	4.5	5.5	Protect Cap
------	-----	-----	-----	-----	-------------

Hex	DUR 2555H [C]	DUR 3555H [C]	DUR 4555H [C]	DUR 5555H [C]	DCUR 55
Non-Hex	DUR 2555N [C]	DUR 3555N [C]	DUR 4555N [C]	DUR 5555N [C]	DCUR 55
Marking	U 25	U 35	U 45	U 55	-

R Post 7.0

Cuff	2.5	3.5	4.5	5.5	Protect Cap
------	-----	-----	-----	-----	-------------

Hex	DUR 2570H [C]	DUR 3570H [C]	DUR 4570H [C]	DUR 5570H [C]	DCUR 70
Non-Hex	DUR 2570N [C]	DUR 3570N [C]	DUR 4570N [C]	DUR 5570N [C]	DCUR 70
Marking	U 27	U 37	U 47	U 57	-

Canine

UFII Angled Abutment Hex Non-Hex

- Packing Unit : Abutment + Abutment Screw + Protect Cap
- Abutment Screw : DASC 2008H (Only compatible with the screw included)

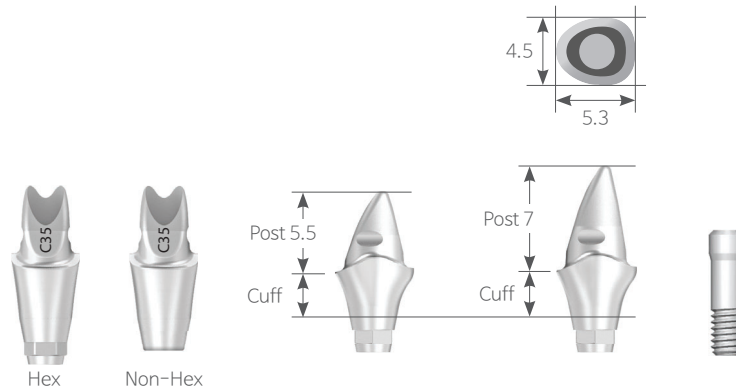

R Post 5.5



Unit mm | Scale 1 : 1.25

Cuff	2.5	3.5	Protect Cap
------	-----	-----	-------------

			
Hex	DCR 2555H [C]	DCR 3555H [C]	DCCR 55
Non-Hex	DCR 2555N [C]	DCR 3555N [C]	DCCR 55
Marking	C 25	C 35	-

R Post 7.0

Cuff	2.5	3.5	Protect Cap
------	-----	-----	-------------

			
Hex	DCR 2570H [C]	DCR 3570H [C]	DCCR 70
Non-Hex	DCR 2570N [C]	DCR 3570N [C]	DCCR 70
Marking	C 27	C 37	-

Pre-Molar

UFII Angled Abutment

Hex Non-Hex

- Packing Unit : Abutment + Abutment Screw + Protect Cap
- Abutment Screw : DASC 2008H (Only compatible with the screw included)

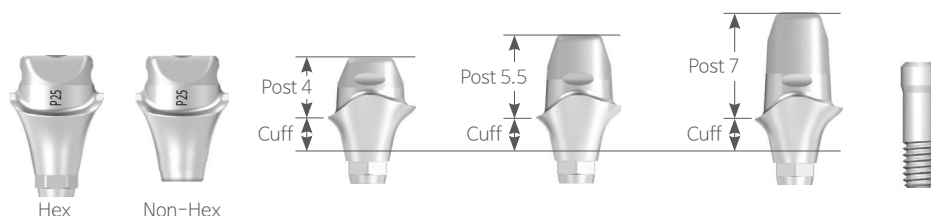
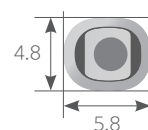

R Post 4.0

Unit mm | Scale 1 : 1.25

Cuff	1.5	2.5	3.5	4.5	Protect Cap
Hex	DPR 1540H [C]	DPR 2540H [C]	DPR 3540H [C]	DPR 4540H [C]	DCPR 40
Non-Hex	DPR 1540N [C]	DPR 2540N [C]	DPR 3540N [C]	DPR 4540N [C]	DCPR 40
Marking	P 14	P 24	P 34	P 44	-

R Post 5.5

Cuff	1.5	2.5	3.5	4.5	Protect Cap
Hex	DPR 1555H [C]	DPR 2555H [C]	DPR 3555H [C]	DPR 4555H [C]	DCPR 55
Non-Hex	DPR 1555N [C]	DPR 2555N [C]	DPR 3555N [C]	DPR 4555N [C]	DCPR 55
Marking	P 15	P 25	P 35	P 45	-

R Post 7.0

Cuff	1.5	2.5	3.5	4.5	Protect Cap
Hex	DPR 1570H [C]	DPR 2570H [C]	DPR 3570H [C]	DPR 4570H [C]	DCPR 70
Non-Hex	DPR 1570N [C]	DPR 2570N [C]	DPR 3570N [C]	DPR 4570N [C]	DCPR 70
Marking	P 17	P 27	P 37	P 47	-

Molar

UFII Angled Abutment Hex Non-Hex

- Packing Unit : Abutment + Abutment Screw + Protect Cap
- Abutment Screw : DASC 2008H (Only compatible with the screw included)

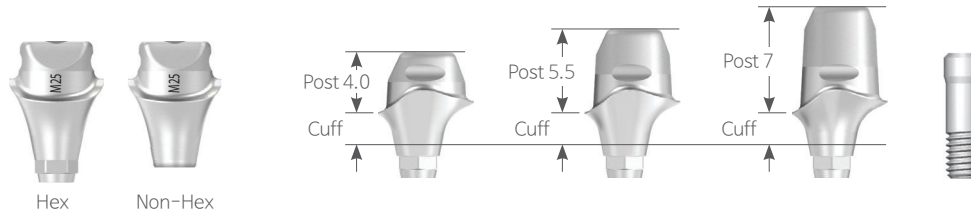
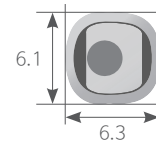

R Post 4.0

Unit mm | Scale 1 : 1.25

Cuff	1.5	2.5	3.5	4.5	Protect Cap
Hex	DMR 1540H [C]	DMR 2540H [C]	DMR 3540H [C]	DMR 4540H [C]	DCMR 40
Non-Hex	DMR 1540N [C]	DMR 2540N [C]	DMR 3540N [C]	DMR 4540N [C]	DCMR 40
Marking	M 14	M 24	M 34	M 44	-

R Post 5.5

Cuff	1.5	2.5	3.5	4.5	Protect Cap
Hex	DMR 1555H [C]	DMR 2555H [C]	DMR 3555H [C]	DMR 4555H [C]	DCMR 55
Non-Hex	DMR 1555N [C]	DMR 2555N [C]	DMR 3555N [C]	DMR 4555N [C]	DCMR 55
Marking	M 15	M 25	M 35	M 45	-

R Post 7.0

Cuff	1.5	2.5	3.5	4.5	Protect Cap
Hex	DMR 1570H [C]	DMR 2570H [C]	DMR 3570H [C]	DMR 4570H [C]	DCMR 70
Non-Hex	DMR 1570N [C]	DMR 2570N [C]	DMR 3570N [C]	DMR 4570N [C]	DCMR 70
Marking	M 17	M 27	M 37	M 47	-

Protect Cap

1. Prevention of gingiva creeping
 - Covering of gum in the margin and gingiva retraction
 - Can accurately take impression with widened gum
2. Protection of the patient's tongue
 - Since the protect cap can fall off while biting food with antagonist teeth (sticky food, etc.), be careful not to swallow the cap if fallen.



How to check the path

Flapless Surgery

- Surgical Guide Fix (Can check height of the gum)

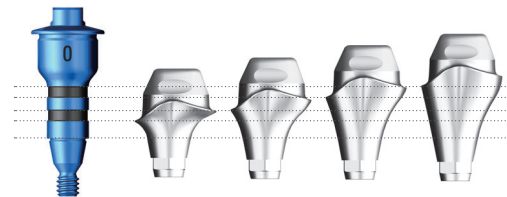

- Setting of hex direction to buccal side when using digital abutment, checking of hex direction using guide sleeve projection
- Can check hex direction using a Guide Sleeve

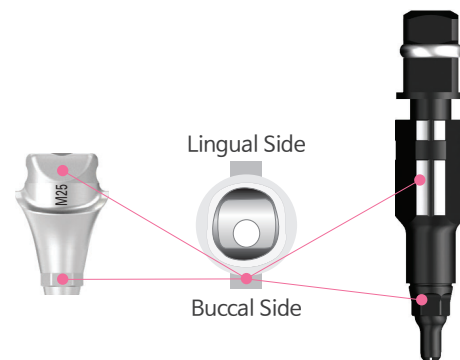

Flap Surgery

- Setting of hex direction to buccal side when using digital abutment,
- Can check hex direction using a fixture driver

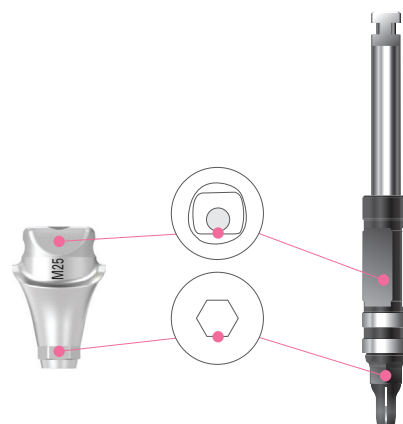

Workflow

DIONavi. + Digital Abutment (Full Digital)

Immediate Restoration

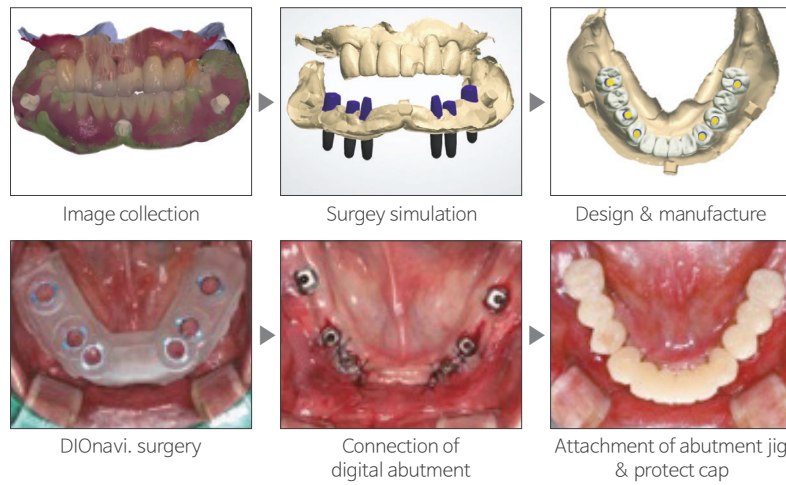

Method of intra oral scan impression

If oral scan is available

Method of library matching
(3Shape Dental System)

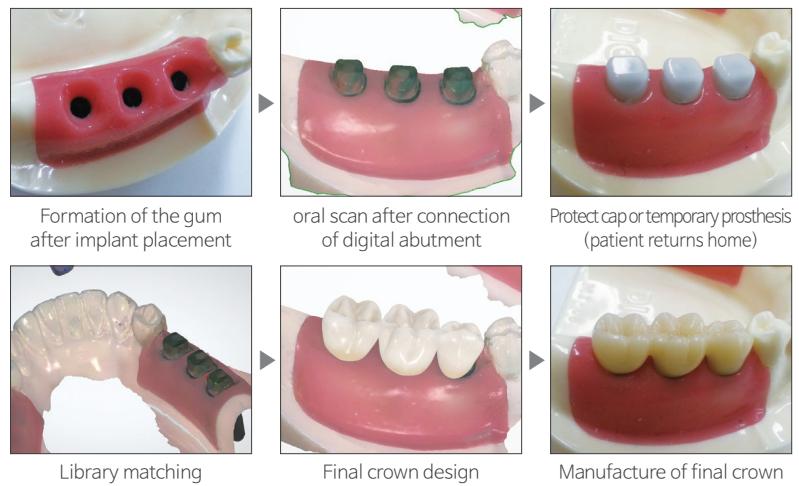

Method of conventional impression

Scanning after manufacture of model

Method of library matching
(3Shape Dental System)









H-Scanbody & Jig

- Tightening Torque : 5~8Ncm
- Packing Unit : H-Scanbody + Screw
- The library can be downloaded from the website.
(<https://hq.dionavi.com/cad/cadlib.do>)

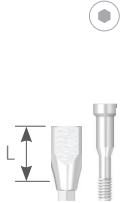
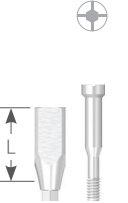
UFII Narrow

Top view

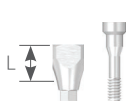
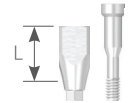
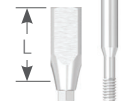
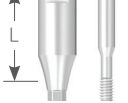



N D Ø4.0 Unit mm | Scale 1 : 1.25

Length	4	6	8	10	12	Jig
						
						
	UNHSB 404H	UNHSB 406H	UNHSB 408H	UNHSB 410H	UNHSB 412H	JIG 401
Screw	UNSCAN 1408H UNSCAN 1410H UNSCAN 1412H UNSCAN 1414H UNSCAN 1416H					

UFII Regular / Wide

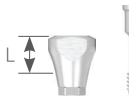
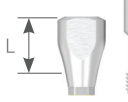

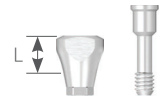
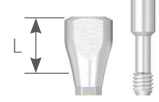





Top view

R W D Ø5.0 Unit mm | Scale 1 : 1.25

Length	4	6	8	Jig
				
				
	HSCAN 541H	HSCAN 561H	HSCAN 581H	JIG 501
Screw	SSCAN 2009H SSCAN 2011H SSCAN 2013H			

Top view

R W D Ø6.0

Length	4	6	8	Jig
				
				
	HSCAN 641H	HSCAN 661H	HSCAN 681H	JIG 601
Screw	SSCAN 2009H SSCAN 2011H SSCAN 2013H			

H-Scanbody

UFII Regular / Wide

Top view



R W D Ø6.0

Unit mm | Scale 1 : 1.25

Length	4	6	8	Jig
Screw	HSCAN 642H SSCAN 2009H	HSCAN 662H SSCAN 2011H	HSCAN 682H SSCAN 2013H	JIG 602

Top view



R W D Ø7.0

Length	4	6	8	Jig
Screw	HSCAN 741H SSCAN 2009H	HSCAN 761H SSCAN 2011H	HSCAN 781H SSCAN 2013H	JIG 701

UFII Regular / Wide

- Only use Multiunit Straight(MSA) / Multiunit Angled(MAA) Abutment
- Use for digital Impression taking
- Uses 1.2 Hex Driver
- Packing Unit : H-Scan body + Screw(MHSBSC 1603)
- Tightening Torque : 5~8Ncm

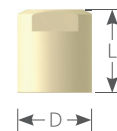

Unit mm | Scale 1 : 2

R W D Ø5.0 Length 5.6

Code	MHSB 5005H
------	------------



Scan Adapter

- Manufacture of customized abutment by connecting to the fixture in the mouth or lab analog of the plaster model and scanning with an oral scanner or desk scanner
- [H] : Hex / [T] : Torx
- The library can be downloaded from the website.
(<https://hq.dionavi.com/cad/cadlib.do>)

UFII Narrow

- Packing Unit : Scan Adapter + Screw
- Tightening Torque : 5~8Ncm

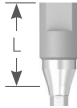

N Unit mm | Scale 1 : 1.25

Length	9	15	Screw
			
SCAN 41	SCAN 41-15	UNSAS 1407H	

UFII Regular / Wide

- Packing Unit : Scan Adapter + Screw
- Tightening Torque : 5~8Ncm

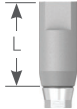
R W Unit mm | Scale 1 : 1.25

Length	9	15	Screw
			
SCAN 01	SCAN 01-15	SSC 2008H	

UFII Regular / Wide

- Only use Multiunit Straight(MSA) / Multiunit Angled(MAA) Abutment
- Uses 1.2 Hex Driver
- Packing Unit : Scan Adapter + Screw (MCSC 1606)
- Tightening Torque : 5~8Ncm

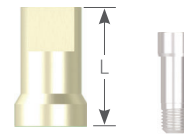

R W D Ø4.8 Length 8 Unit mm | Scale 1 : 2

Code	MSCAN 4808H

Scan Retractor

- Precise recognition of maxillar open repository and archive
- Controlling the cheek and tongue mobility at mandibular open repository and archive
- Providing the exact reference point of the marginal scanning area
- Packing Unit : Maxillar – Set (5 Piece) Mandibular – Set (5 Piece)



Type	Maxillar	Mandibular
	SCANR 01S	SCANR 02S

Wax Denture

► Made of thermoplastic material that allows easy operation to acquire occlusion with patient's gingiva

- For edentulous patients
- Easily customized
- Enable oral scan
- Packing Unit : Maxillar-1 Piece / Mandibular-1 Piece



Type	Maxillar	Mandibular
Small	WDU 01	WDL 01
Medium	WDU 02	WDL 02
Large	WDU 03	WDL 03

Marker

- Use when they have no teeth for reference
- Use for CT imaging for digital implant surgery
- Packing Unit : 1 Set (30ea)



Type	SGM 5040

Pre-Milled Bar

UFII Narrow

- Packing Unit : Pre-Milled Bar + Screw (UNSA5 1407H) 2ea
- Tightening Torque : 20Ncm



Unit mm | Scale 1:1

Type	Hex		Non-Hex	
	Diameter	Ø10	Ø12	Ø10
	CBUN 01 [H]	CBUN 02 [H]	CBUN 01N [H]	CBUN 02N [H]

UFII Regular / Wide

- Packing Unit : Pre-Milled Bar + Screw (SSC 2008H) 2ea
- Tightening Torque : 30~35Ncm



Unit mm | Scale 1:1

Type	Hex		Non-Hex	
	Diameter	Ø10	Ø12	Ø10
	CBSS 01 [H]	CBSS 02 [H]	CBSS 01N [H]	CBSS 02N [H]

Hybrid Link

- Up to implant platform connection part is made of titanium, making it easy to produce prosthesis for anterior region by cementation the post made of zirconia.
- The library can be downloaded from the website.
(<https://hq.dionavi.com/cad/cadlib.do>)

UFII Narrow

- Packing Unit : Hybrid Link + Screw (UNSA1407H)
- Tightening Torque : 20Ncm

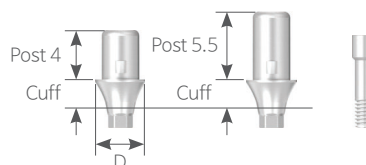

N D Ø4.0

Unit mm | Scale 1 : 1.65

Type			Hex	
Diameter Ø4.0	Post 4	Cuff 1	UNHL	40401H
		Cuff 2	UNHL	40402H
		Cuff 3	UNHL	40403H
	Post 5.5	Cuff 1	UNHL	40551H
		Cuff 2	UNHL	40552H
		Cuff 3	UNHL	40553H

UFII Regular / Wide

- Packing Unit : Hybrid Link + Screw (SSC 2008H)
- Tightening Torque : 30~35Ncm

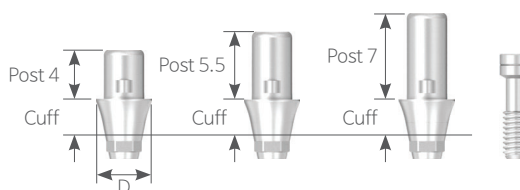

R W

Unit mm | Scale 1 : 1.65

Type			Hex		Non-Hex		
Diameter Ø4.5	Post 4	Cuff 1	UFHL	45401H [H]	UFHL	45401N [H]	
		Cuff 2	UFHL	45402H [H]	UFHL	45402N [H]	
		Cuff 3	UFHL	45403H [H]	UFHL	45403N [H]	
	Post 5.5	Cuff 1	UFHL	45501H [H]	UFHL	45501N [H]	
		Cuff 2	UFHL	45502H [H]	UFHL	45502N [H]	
		Cuff 3	UFHL	45503H [H]	UFHL	45503N [H]	
	Post 7	Cuff 1	UFHL	45701H [H]	UFHL	45701N [H]	
		Cuff 2	UFHL	45702H [H]	UFHL	45702N [H]	
		Cuff 3	UFHL	45703H [H]	UFHL	45703N [H]	
	Diameter Ø5.5	Post 4	Cuff 1	UFHL	55401H [H]	UFHL	55401N [H]
			Cuff 2	UFHL	55402H [H]	UFHL	55402N [H]
			Cuff 3	UFHL	55403H [H]	UFHL	55403N [H]
		Post 5.5	Cuff 1	UFHL	55501H [H]	UFHL	55501N [H]
			Cuff 2	UFHL	55502H [H]	UFHL	55502N [H]
			Cuff 3	UFHL	55503H [H]	UFHL	55503N [H]
Post 7		Cuff 1	UFHL	55701H [H]	UFHL	55701N [H]	
		Cuff 2	UFHL	55702H [H]	UFHL	55702N [H]	
		Cuff 3	UFHL	55703H [H]	UFHL	55703N [H]	

Digital Fixture Analog

- Provides anchor point for abutment on 3D printed model.
- The library can be downloaded from the website.
(<https://hq.dionavi.com/cad/cadlib.do>)

N R W Hex		Unit mm Scale 1 : 65			
Fixture Size	Narrow		Regular · Wide		
Diameter	Ø3.0	Ø3.5	Ø4.5	Ø4.8	
Hex	1.7		2.5		
Length	9	12.5	11	12.5	
Code	DAU 3009	DAUN 3512	DAU 4509	DAU 4812	

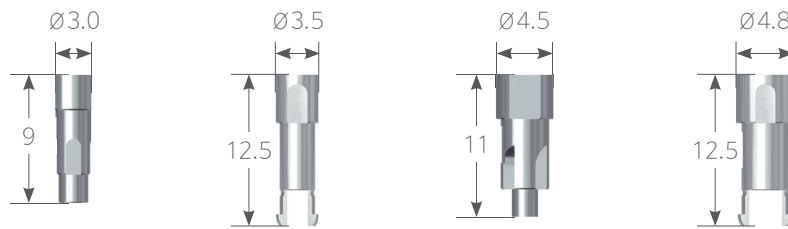

UFII Master Kit Kit Code | UF(M) 06

- Kit composed of drill with outstanding cutting force and durability, etc.
- UFII Narrow $\varnothing 3.0$ $\varnothing 3.3$ / UFII Regular $\varnothing 3.8$ $\varnothing 4.0$ $\varnothing 4.5$ $\varnothing 5.0$ Fixture

Unit mm | Drill Scale 1 : 0.9

Initial Drill
DSU 2008M
DSU 2010M
DSU 2011M
DSU 2013M

Parallel Pin
PP 2022 · PP 2023

Drill
DSU 2708M · DSU 3008M · DSU 3208M · DSU 3808M · DSU 4308M
DSU 2710M · DSU 3010M · DSU 3210M · DSU 3810M · DSU 4310M
DSU 2711M · DSU 3011M · DSU 3211M · DSU 3811M · DSU 4311M
DSU 2713M · DSU 3013M · DSU 3213M · DSU 3813M · DSU 4313M

Starter Drill
SD 1530M

Lindemann Drill
RMH 2014S

Drill Extension
DE 3811

Abutment Removing Driver
HARD 20315A

Ball Abutment Driver
HD 2412A

Solid Abutment Driver
HDS 4506A · HDS 5506A · HDS 6506A
HDS 4512A · HDS 5512A · HDS 6512A

Tap Drill
UNTD 3015
UNTD 3315

Fixture Driver
UNFDC 3012
UNFDC 3018
UNFDW 3012
UNFDW 3018

Screw Driver
MD 1230
HD 1215A

Fixture Driver
FDC 3506 · FDW 3512A
FDC 3512 · FDW 3518A

Mount Fixture Driver
MHDC 2520
MHDR 2513A

Profile Drill
UPD 3805M
UPD 4005M
UPD 4505M
UPD 5005M

Torque Wrench
DTW 0060

Open Wrench
OW 004

Depth Gauge
DPG 2050

Ver A

UFII Surgical Kit

Kit Code | UF(M) 07

- Kit composed of drill with outstanding cutting force and durability, etc.
- UFII Narrow $\varnothing 3.0$ $\varnothing 3.3$ / UFII Regular $\varnothing 3.8$ $\varnothing 4.0$ $\varnothing 4.5$ $\varnothing 5.0$ $\varnothing 5.5$ Fixture

Unit mm | Drill Scale 1 : 0.9

Lindemann Drill
RMH 2014S

Starter Drill
SD 1530M

Initial Drill
DHF 2015SM

Parallel Pin
PP 2022
PP 2023

Drill
DSU 2708M · DSU 3008M · DSU 3208M · DSU 3808M · DSU 4308M
DSU 2710M · DSU 3010M · DSU 3210M · DSU 3810M · DSU 4310M
DSU 2711M · DSU 3011M · DSU 3211M · DSU 3811M · DSU 4311M
DSU 2713M · DSU 3013M · DSU 3213M · DSU 3813M · DSU 4313M

Profile Drill
UPD 3805M
UPD 4005M
UPD 4505M
UPD 5005M

Drill Extension
DE 3811

Tap Drill
UNTD 3015
UNTD 3315

Fixture Driver
UNFDC 3012 · UNFDW 3012
UNFDC 3018 · UNFDW 3018

Screw Driver
MD 1230
HD 1215A

Fixture Driver
FDC 3506 · FDW 3512A
FDC 3512 · FDW 3518A

Drill Stopper
ST 2008F · ST 2011F
ST 2010F · ST 2013F

CE 0123

Torque Wrench
DTW 0060

Open Wrench
OW 004

Depth Gauge
DPG 2050

Ver B

Surgical Tool

Starter Drill

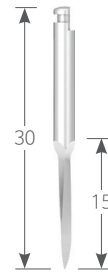

Unit mm | Scale 1 : 1.15

K

Code

SD 1530M

Initial Drill

K D Ø2.0 · Only use UFII Master Kit

Unit mm | Scale 1 : 1

Code

DSU 2008M

DSU 2010M

DSU 2011M

DSU 2013M

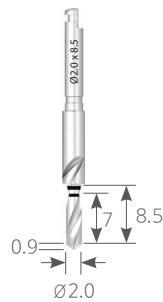

K D Ø2.0 · Only use UFII Surgical Kit

Unit mm | Scale 1 : 1.2

Code

DHF 2015SM

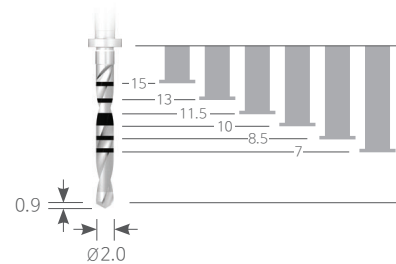

Drill stopper

K D Ø2.0

Unit mm | Scale 1 : 1.2

Code

ST 2013F

ST 2011F

ST 2010F

ST 2008F



Parallel Pin

K

● Sold separately
Unit mm | Scale 1 : 1

Code	PP 1223	PP 1523	PP 2015	PP 2022	PP 2023

Path Pin

K

● Sold separately
Unit mm | Scale 1 : 1.2

Code	DPP 3512

Surgical Tool

Lindemann Drill

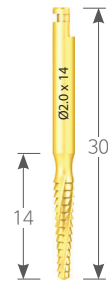

Unit mm | Scale 1 : 1.2

K D Ø2.0

Code

RMH 2014S

Positioning Guide



● Sold separately

Unit mm | Scale 1 : 1.2

K D Ø2.0

Code

PG 0060

Angled Path Pin

● Sold separately

Unit mm | Scale 1 : 1.15

K

Code

DAP 4515A

DAP 4515B



Hex A



Hex B

Type

|

Drill



K D Ø2.7

● Sold separately
Unit mm | Scale 1:1

Code	DSU 2707M	DSU 2708M	DSU 2710M	DSU 2711M	DSU 2713M	DSU 2715M
------	------------------	-----------	-----------	-----------	-----------	------------------

Length	7	8.5	10	11.5	13	15

K D Ø3.0

Unit mm | Scale 1:1

Code	DSU 3007M	DSU 3008M	DSU 3010M	DSU 3011M	DSU 3013M	DSU 3015M
------	------------------	-----------	-----------	-----------	-----------	------------------







Length	7	8.5	10	11.5	13	15

Drill

K D Ø3.2







● Sold separately

Unit mm | Scale 1:1

Code	DSU 3207M	DSU 3208M	DSU 3210M	DSU 3211M	DSU 3213M	DSU 3215M
						
Length	7	8.5	10	11.5	13	15







K D Ø3.8

Unit mm | Scale 1:1

Code	DSU 3807M	DSU 3808M	DSU 3810M	DSU 3811M	DSU 3813M	DSU 3815M
						
Length	7	8.5	10	11.5	13	15

K D Ø4.3

Unit mm | Scale 1:1

Code	DSU 4307M	DSU 4308M	DSU 4310M	DSU 4311M	DSU 4313M	DSU 4315M
						
Length	7	8.5	10	11.5	13	15

Profile Drill

● Sold separately

Unit mm | Scale 1:1

K

Fixture Size	Ø3.8	Ø4.0	Ø4.5	Ø5.0	Ø5.5
Code	UPD 3805M	UPD 4005M	UPD 4505M	UPD 5005M	UPD 5505M

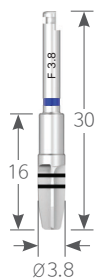

Color



Tap Drill

● Sold separately

Unit mm | Scale 1:1

K

Fixture Size	Ø3.0	Ø3.3	Ø3.8	Ø4.0	Ø4.5	Ø5.0	Ø5.5
Code	UNTD 3015	UNTD 3315	UT(II) 3815	UT(II) 4015	UT(II) 4515	UT(II) 5015	UT(II) 5515



Color



Drill Extension

· Length is extended 15.5mm by connecting to the drill.



K

Unit mm | Scale 1:1.2

Code	DE 3811
------	---------

Surgical Tool

Fixture Driver Narrow

K Machine

● Sold separately

Unit mm | Scale 1:1

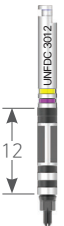
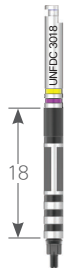
Code	UNFDC 3006	UNFDC 3012	UNFDC 3018
			

K Ratchet

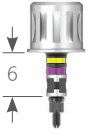
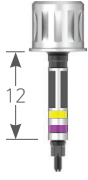
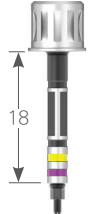
Code	UNFDW 3006	UNFDW 3012	UNFDW 3018
			

Fixture Driver Regular / Wide



K Machine

● Sold separately

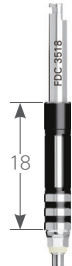
Unit mm | Scale 1:1

Code	FDC 3506	FDC 3512	FDC 3518
			

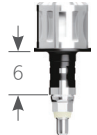
K Ratchet

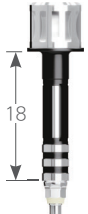
Code	FDW 3506A	FDW 3512A	FDW 3518A
			

Screw Driver Machine

● Sold separately

Unit mm | Scale 1:1

K Slot 0.5

Code	MD 0522	MD 0530
------	---------	---------



K Hex 0.9

Code	MD 0922	MD 0930
------	---------	---------



K Hex 1.2

Code	MD 1219	MD 1222	MD 1230	MD 1234	MD 1239
------	---------	---------	---------	---------	---------



K Torx 1.7

Code	MD 1719	MD 1722	MD 1730
------	---------	---------	---------

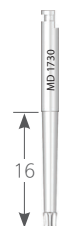

Surgical Tool

Screw Driver Ratchet

● Sold separately

Unit mm | Scale 1:1

K Slot 0.5

Code

HD 0510A

HD 0515A

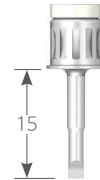
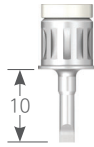

K Hex 0.9

Code

HD 0910A

HD 0915A

HD 0920A

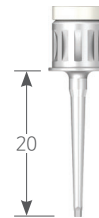
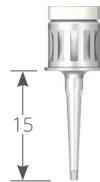
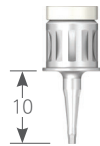

K Hex 1.2

Code

HD 1205A

HD 1210A

HD 1215A

HD 1220A

HD 1225A

HD 1230A

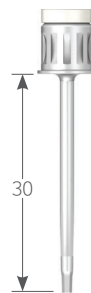
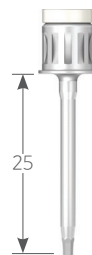
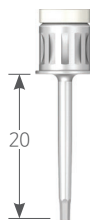
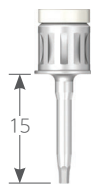
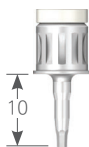
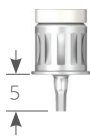

K Torx 1.7

Code

HD 1705A

HD 1710A

HD 1715A

HD 1720A

HD 1725A

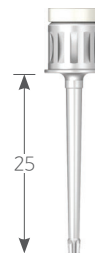
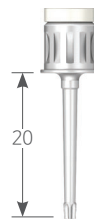
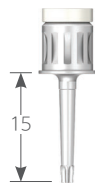
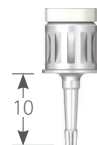
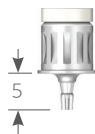

Mount Fixture Driver

· Only use UF II Master Kit

● Sold separately

K Hex 2.5

Unit mm | Scale 1:1

Type	Machine		Ratchet	
Code	MHDC 2520	MHDC 2525	MHDR 2513A	MHDR 2518A

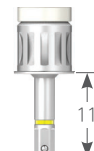
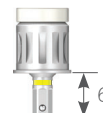

Solid Abutment Driver

· Only use UF II Master Kit

K

Unit mm | Scale 1:1.2

Length	6	12
--------	---	----

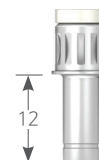

Diameter Ø4.5	HDS 4506A	HDS 4512A
Ø5.5	HDS 5506A	HDS 5512A
Ø6.5	HDS 6506A	HDS 6512A

Ball Abutment Driver

· Only use UF II Master Kit

K

● Sold separately

Unit mm | Scale 1:1

Code	HD 2406A	HD 2412A
------	----------	----------

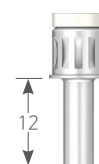
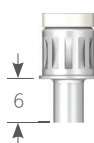

Surgical Tool

Abutment Removing Driver

· Only use UF II Master Kit

● Sold separately

Unit mm | Scale 1:1

K	Code	HARD 20315A	HARD 20320A
----------	------	-------------	-------------

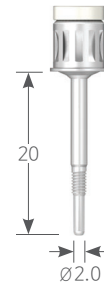
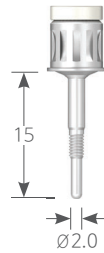

Depth Gauge

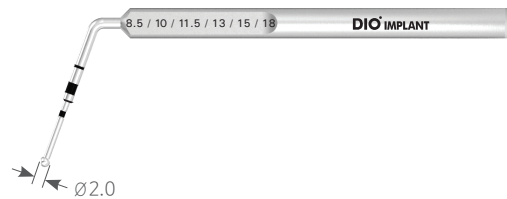

K D Ø2.0	Code	DPG 2050	Unit mm Scale 1:1
-----------------	------	----------	---------------------

Open Wrench

- Used to remove Mount if the bone is soft.
- 30° Neck angle for convenience in intraoral insertion.



K	Code	OW 004	Unit mm Scale 1:1
----------	------	--------	---------------------

Torque Wrench



K	Unit mm Scale 1 : 1
Code	DTW 0060

Surgical Protocol

Crestal Placement

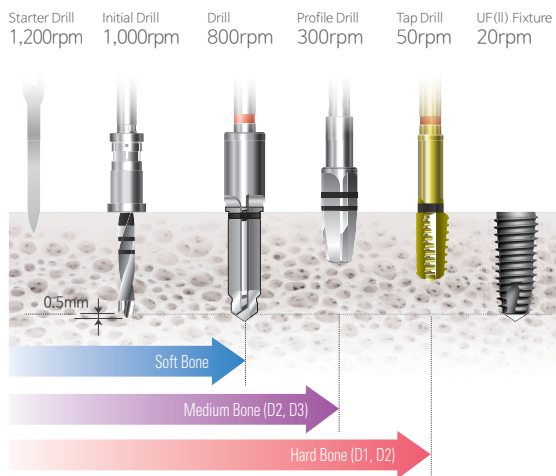

1mm Subcrestal Placement

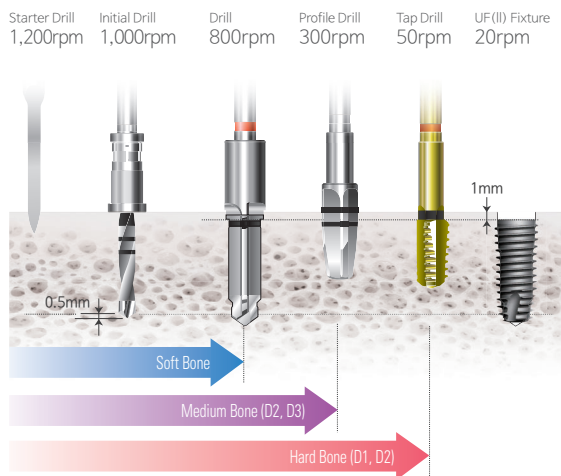

Drill
Using 8.5mm Drill with laser marking to place 7mm implant

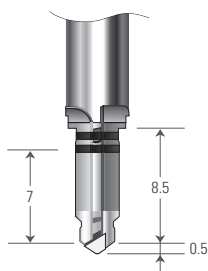

Profile Drill

Drilling depth can effect initial stability.

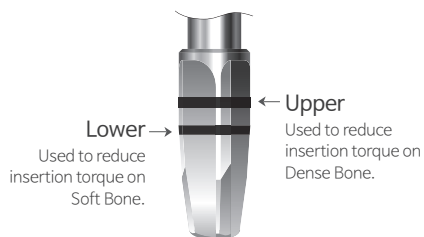

Tap Drill

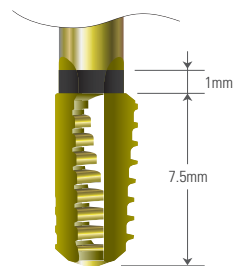

UFII Narrow Kit Kit Code | UF(M) 08

- Kit composed of drill with outstanding cutting force and durability, etc.
- UFII Narrow $\varnothing 3.0$ $\varnothing 3.3$ Fixture

Unit mm | Drill Scale 1 : 0.9

Starter Drill
SD 1530M

Initial Drill
DHF 2015SM

Parallel Pin
PP 2022 · PP 2023

Drill
DSU 2708M · DSU 2710M
DSU 2711M · DSU 2713M

Drill Stopper
ST 2008F · ST 2011F
ST 2010F · ST 2013F

Tap Drill
UNTD 3015
UNTD 3315

1.2 Hex Screw Driver
MD 1230
HD 1220A

Fixture Driver
UNFDC 3012 · UNFDW 3012
UNFDC 3018 · UNFDW 3018

Depth Gauge
DPG 2050

Torque Wrench
DTW 0060

UFII Narrow

DIO IMPLANT

Fixture Dia. $\varnothing 3.0$ / $\varnothing 3.3$
Drill Dia. $\varnothing 2.7$

Spare

Machine Ratchet

Screw Driver Machine Ratchet

CE 0123

Surgical Tool

Starter Drill

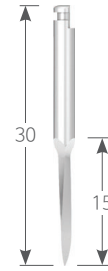

K

Unit mm | Scale 1:1.2

Code	SD 1530M
------	----------

Initial Drill

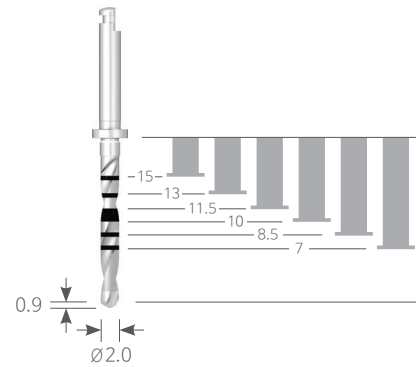

K D Ø2.0

Unit mm | Scale 1:1.2

Code	DHF 2015SM
------	------------

Drill stopper

K D Ø2.0

Unit mm | Scale 1:1.2

Code	ST 2013F	ST 2011F	ST 2010F	ST 2008F
------	----------	----------	----------	----------



Parallel Pin

K D Ø2.0

Unit mm | Scale 1:1

Code	PP 2022	PP 2023
------	---------	---------

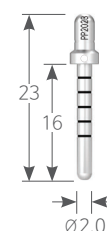
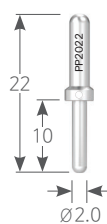

Surgical Tool

Drill

K D Ø2.7

Unit mm | Scale 1:1

Code	DSU 2708M	DSU 2710M	DSU 2711M	DSU 2713M
------	-----------	-----------	-----------	-----------

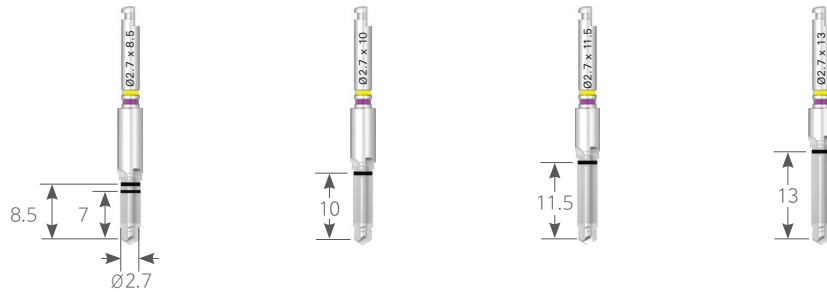

Tap Drill

K

Unit mm | Scale 1:1

Fixture Size	Ø3.0	Ø3.3
Code	UNTD 3015	UNTD 3315

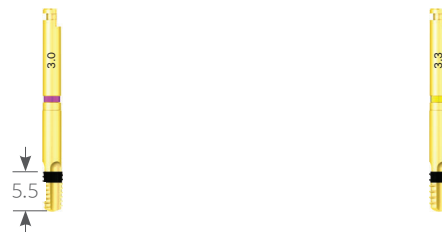

Fixture Driver

- Maximum Tightening Torque : 50Ncm
- Drill lifespan : 20 osteotomies

● Sold separately

K

Unit mm | Scale 1:1

Type	Machine			Ratchet		
Code	UNFDC 3006	UNFDC 3012	UNFDC 3018	UNFDW 3006	UNFDW 3012	UNFDW 3018

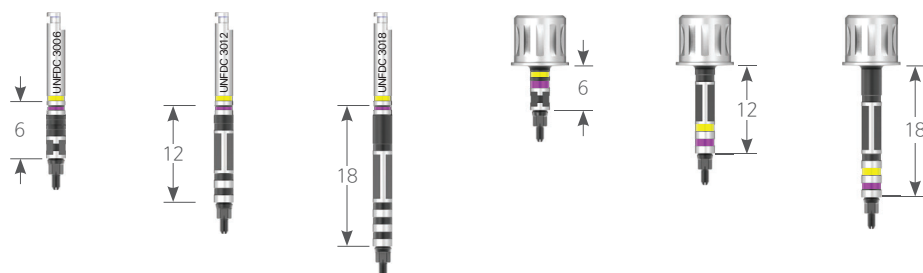

Screw Driver

K Hex 1.2

Unit mm | Scale 1 : 1

Type	Machine	Ratchet
Code	MD 1230	HD 1220A

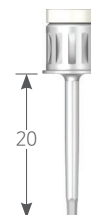

Solid Abutment Driver

· Only use UFII Narrow Kit

K D Ø4.0

● Sold separately

Unit mm | Scale 1 : 1

Length	6	12
Code	UNHDS 4006A	UNHDS 4012A

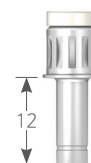
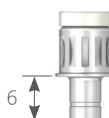

Surgical Protocol

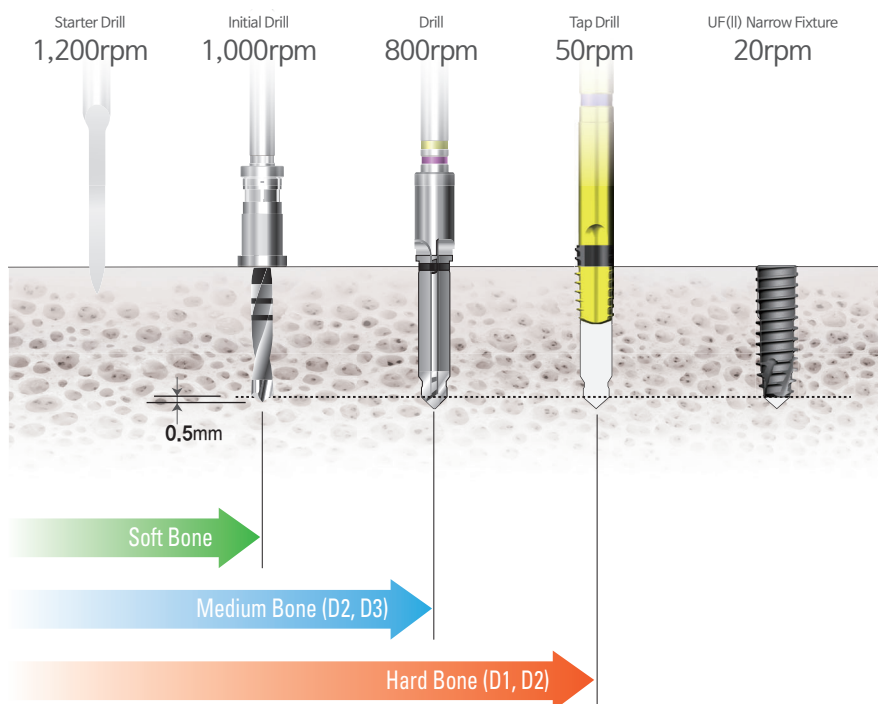

Tap Drill

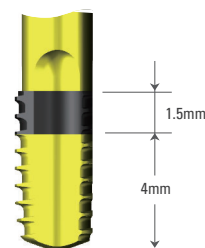

· Tightening torque : 20~40Ncm
Maximum tightening torque : 50Ncm

UFII Wide Kit Kit Code | UF 09

- Kit composed of drill with outstanding cutting force and durability, etc.
- UFII Wide $\varnothing 5.9$ $\varnothing 6.4$ $\varnothing 6.9$ Fixture

Unit mm | Drill Scale 1 : 0.9

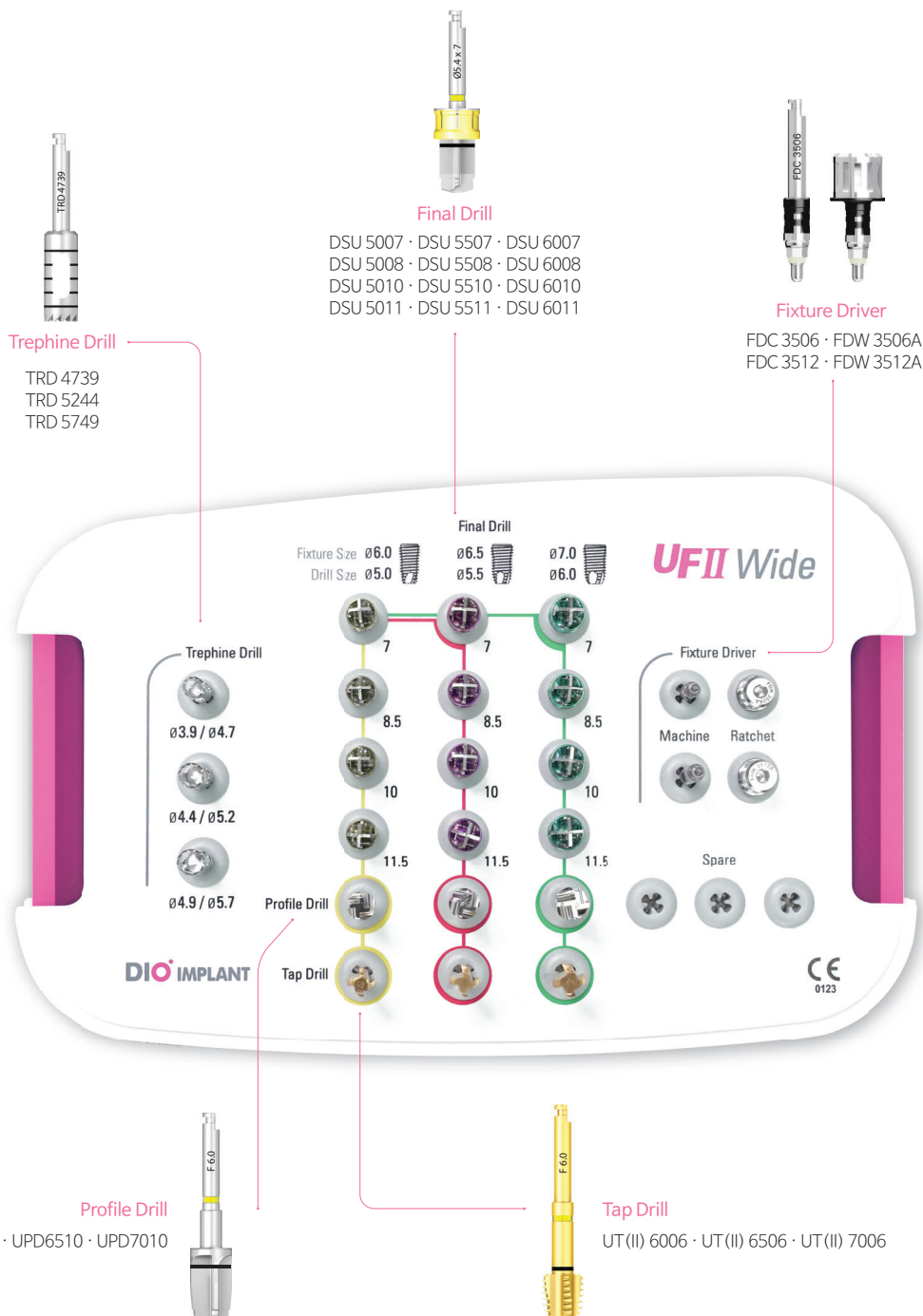

Surgical Tool

Trephine Drill



Scale 1 : 1.15

K

Unit mm | Scale 1 : 1

Code	TRD 4739	TRD 5244	TRD 5749
------	----------	----------	----------



Diameter 1	Ø3.9	Ø4.4	Ø4.9
Diameter 2	Ø4.7	Ø5.2	Ø5.7

Profile Drill



Scale 1 : 1.15

K

Unit mm | Scale 1 : 1

Fixture Size	Ø6.0	Ø6.5	Ø7.0
Code	UPD 6010	UPD 6510	UPD 7010



Color	●	●	●
-------	---	---	---

Surgical Tool

Final Drill



K D Ø5.0

● Sold separately
Unit mm | Scale 1:1

Code	DSU 5007	DSU 5008	DSU 5010	DSU 5011	DSU 5013	DSU 5015
Length	7	8.5	10	11.5	13	15

K D Ø5.5

Code	DSU 5507	DSU 5508	DSU 5510	DSU 5511	DSU 5513	DSU 5515
Length	7	8.5	10	11.5	13	15

K D Ø6.0

Code	DSU 6007	DSU 6008	DSU 6010	DSU 6011	DSU 6013	DSU 6015
Length	7	8.5	10	11.5	13	15

Tap Drill

K	Unit mm Scale 1:1		
Fixture Size	Ø6.0	Ø6.5	Ø7.0
Code	UT(II) 6006	UT(II) 6506	UT(II) 7006



Color



Fixture Driver

K	● Sold separately Unit mm Scale 1:1		
Type	Machine		Ratchet
Code	FDC 3506	FDC 3512	FDC 3518
			FDW 3506A
			FDW 3512A
			FDW 3518A

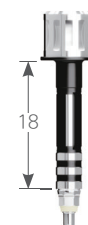
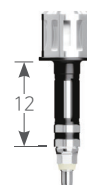
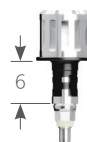
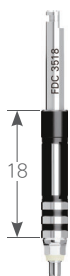

Surgical Protocol

Fixture Length 7mm

Extraction Socket & Replace failed Implant

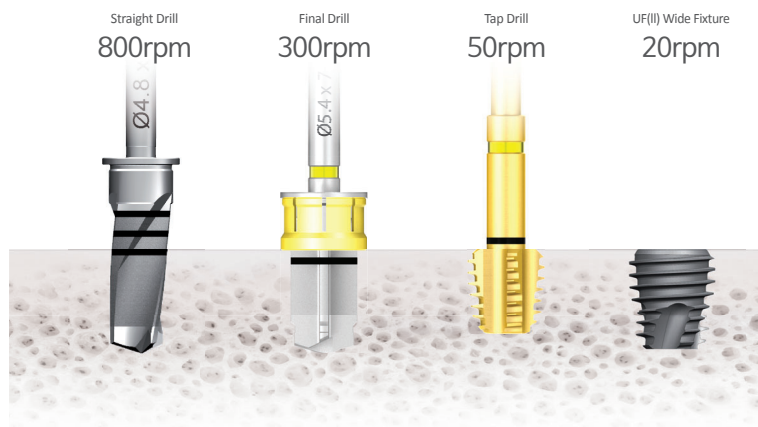

DIO IMPLANT
www.dioimplant.com

DIOnavi. Kit

DIOnavi. Master Kit Kit Code | UF(M) 05

- Kit composed of drill with outstanding cutting force and durability, etc.
- UFII Narrow $\varnothing 3.0$ $\varnothing 3.3$ UF(II) Regular $\varnothing 3.8$ $\varnothing 4.0$ $\varnothing 4.5$ $\varnothing 5.0$ Fixture
- Guide Sleeve : GS 53

Unit mm | Drill Scale 1 : 0.9

Screw Driver
MD 1222·MD1230

Drill Extension
DE 3811

Screw Driver
HD 1215A

Square Screw Driver
SHD 1215
SHD 1220

Tissue Punch
GTP 5125

Drill Tube
UDT 20
UDTE 20

Bone Flattening Drill
UBFD 5127M

Guide Drill
UGD 2007RM

Initial Drill
ISD 2013M
ISD 2011M
ISD 2010M
ISD 2008M
ISD 2007M
ISD 2005M

Final Drill
USD 2713M USD 3013M USD 3213M USD 3813M USD 4313M
USD 2711M USD 3011M USD 3211M USD 3811M USD 4311M
USD 2710M USD 3010M USD 3210M USD 3810M USD 4310M
USD 2708M USD 3008M USD 3208M USD 3808M USD 4308M
USD 2707M USD 3007M USD 3207M USD 3807M USD 4307M
USD 2705M

Profile Drill
GPD 3005M
GPD 3305M
GPD 3805M
GPD 4005M
GPD 4505M
GPD 5005M

Abutment Profile Drill
UAPD 5123M
UAPD 5124M
UAPD 5126M

Connector Extension
CE 6512M·CE 6512A
CE 6508M·CE 6508A

Implant Connector
GNIC 5309ST·GNIC 5309
GIC 5309ST·GIC 5309

Torque Wrench
DTW 0080

Surgical Tool

Tissue Punch

- Gingiva can be removed stably using a fixed blade inside the punch.
(Flapless Surgery)



K D $\varnothing 3.0$

Unit mm | Scale 1 : 1

Code

GTP 5125

Bone Flattening Drill

- Remaining gingiva is removed for easier drilling,
and irregular alveolar crest is flattened.

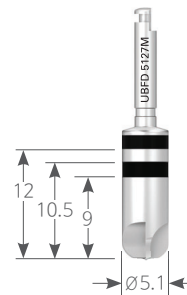

K D $\varnothing 5.1$

Unit mm | Scale 1 : 1

Code

UBFD 5127M

Guide Drill

- A hole on the bone is initially formed
on the bone for easier insertion of the initial drill.



K D $\varnothing 2.0$ Length 5

Unit mm | Scale 1 : 1

Code

UGD 2005RM

Drill Extension

- Length is extended 15.5mm by connecting to the drill.



K Length 11

Unit mm | Scale 1 : 1

Code

DE 3811

Surgical Tool

Drill Tube

· To fix the guide drill and the initial drill without shakage.



● Sold separately

Unit mm | Scale 1:1

Code	UDT 20	UDTE 20	UDTL 20
------	--------	---------	---------



Initial Drill

· A placement hole(osteotomy site) is formed on the cortical bone.

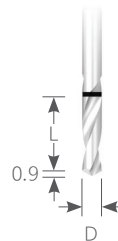

● Sold separately

Unit mm | Scale 1:1

Code	ISD 2005M	ISD 2007M	ISD 2008M	ISD 2010M	ISD 2011M	ISD 2013M	ISD 2015M
------	-----------	-----------	-----------	-----------	-----------	-----------	-----------



Profile Drill

- The cortical bone is further drilled in D1 and D2 bones, and excessive placement torque is prevented.

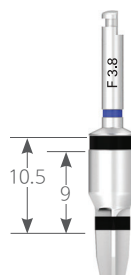

K		Unit mm Scale 1 : 1					
Fixture Size	Ø3.0	Ø3.3	Ø3.8	Ø4.0	Ø4.5	Ø5.0	
Code	GPD 3005M	GPD 3305M	GPD 3805M	GPD 4005M	GPD 4505M	GPD 5005M	



Color



Bone Profile Drill

- When connecting abutment (healing) after implant placement, It is necessary to contour the bone for proper seating of the abutments. (to contour bone to allow for a wider emergence profile restoration)
- To flatten and remove bone that has grown around or over an implant which impedes its restoration. (When use a Abutment (with Healing Abutment))

● Sold separately

K		Unit mm Scale 1 : 1	
Type		Narrow	Regular
Code		BPD 4616GN	BPD 5608G

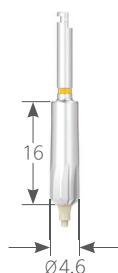

Surgical Tool

Final Drill

· The drill hole is expanded to the final drilling.

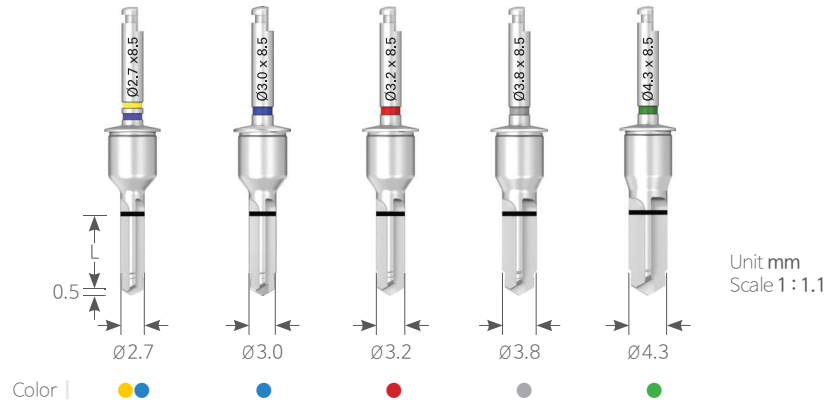

K D Ø2.7

● Sold separately

Unit mm | Scale 1:1

Code USD 2705M USD 2707M USD 2708M USD 2710M USD 2711M USD 2713M **USD 2715M**

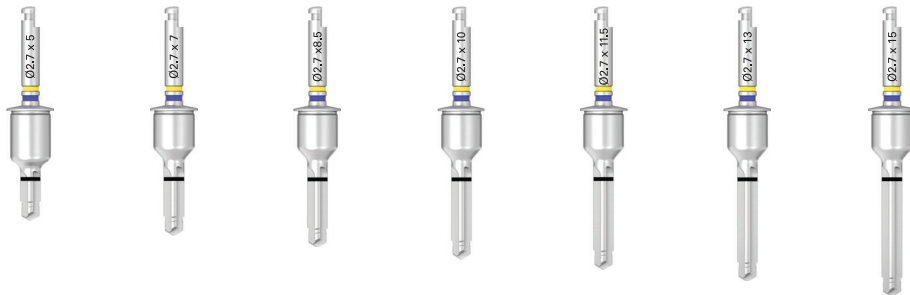

Length | 5 7 8.5 10 11.5 13 15

K D Ø3.0

Unit mm | Scale 1:1

Code **USD 3005M** USD 3007M USD 3008M USD 3010M USD 3011M USD 3013M **USD 3015M**



Length | 5 7 8.5 10 11.5 13 15

K D Ø3.2

● Sold separately

Unit mm | Scale 1 : 1

Code **USD 3205** USD 3207M USD 3208M USD 3210M USD 3211M USD 3213M **USD 3215M**



Length | 5 7 8.5 10 11.5 13 15

K D Ø3.8

Unit mm | Scale 1 : 1

Code **USD 3805** USD 3807M USD 3808M USD 3810M USD 3811M USD 3813M **USD 3815M**



Length | 5 7 8.5 10 11.5 13 15

K D Ø4.3

Unit mm | Scale 1 : 1

Code **USD 4305** USD 4307M USD 4308M USD 4310M USD 4311M USD 4313M **USD 4315M**



Length | 5 7 8.5 10 11.5 13 15

Surgical Tool

Tap Drill

- Excessive implant placement torque is prevented.
- $\varnothing 3.0/\varnothing 3.3$: Uses 5.3 Sleeve (GS 53BL: Blue)

● Sold separately

K						
Fixture Size	$\varnothing 3.0$	$\varnothing 3.3$	$\varnothing 3.8$	$\varnothing 4.0$	$\varnothing 4.5$	$\varnothing 5.0$
Code	GNTD 3015	GNTD 3315	GTD 3815	GTD 4015	GTD 4515	GTD 5015

Unit mm | Scale 1 : 1

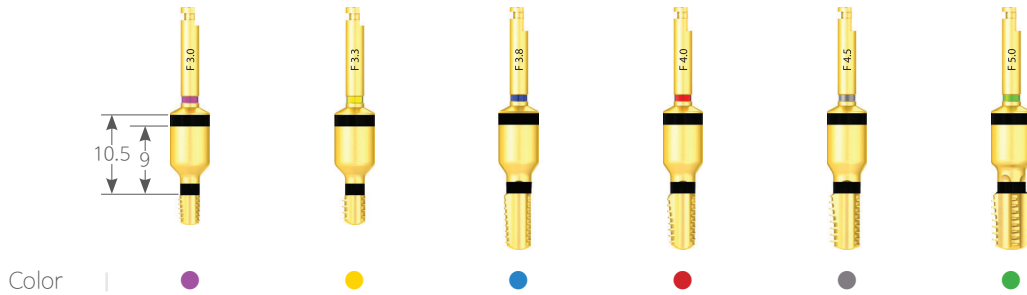

Abutment Profile Drill

- The cortical bone disrupting sitting of the abutment is removed, and emergence profile is formed.

K			
Code	UAPD 5123M	UAPD 5124M	UAPD 5126M

Unit mm | Scale 1 : 1

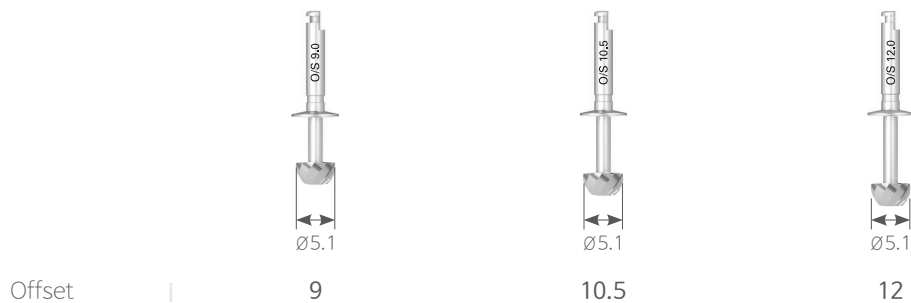

Connector Extension

- Length of the connector is extended during implant placement.

K				
Code	CE 6508A	CE 6508M	CE 6512A	CE 6512M

Unit mm | Scale 1 : 1

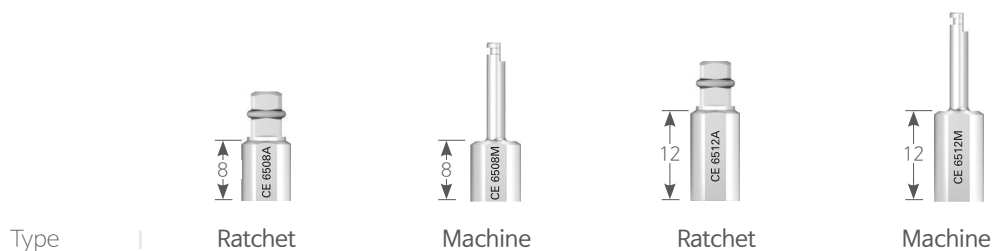

Implant Connector

- Implant is placed according to depth of the fixture and direction of the internal hex planned in advance.
- Recommended use of UF(II) Narrow : 20 times / Be careful about excessive torque of 50Ncm or above.

● Sold separately

K

Unit mm | Scale 1 : 1

Fixture Size	Ratchet			Machine
Code	Non-Stopper	Stopper	Multi	Non-Stopper

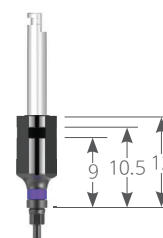
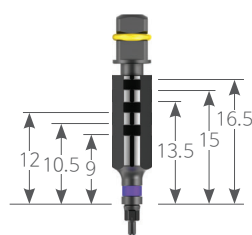
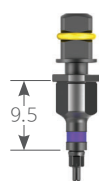
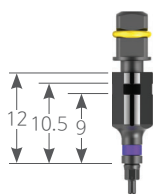

UF II **Narrow**

GNIC 5309

GNIC 5309ST

GNIC 5317

GNICC 5309

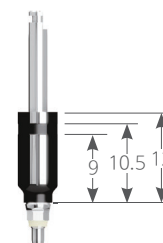
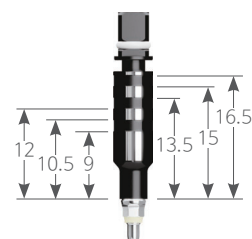
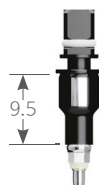
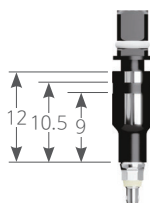

UF II **Regular**

GIC 5309



GIC 5309ST

GIC 5317

GICC 5309

Surgical Tool

Screw Driver

K Hex 1.2		Unit mm Scale 1:1	
Code	MD 1222	MD 1230	
			
Type	Machine	Machine	

Sqaure Screw Driver

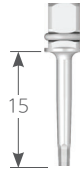
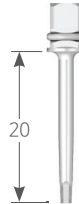
K Hex 1.2		Unit mm Scale 1:1	
Code	SHD 1215	SHD 1220	
			
	Ratchet	Ratchet	

Torque Wrench

· To place the fixture using an implant connector



K			
Code	DTW 0080		

DIOnavi. Narrow Kit Kit Code | UF 14

- Kit composed of drill with outstanding cutting force and durability, etc.
- UF(II) Narrow $\varnothing 3.0$ $\varnothing 3.3$ Fixture
- Guide Sleeve : GSL 36, GS36

Unit mm | Drill Scale 1 : 0.9

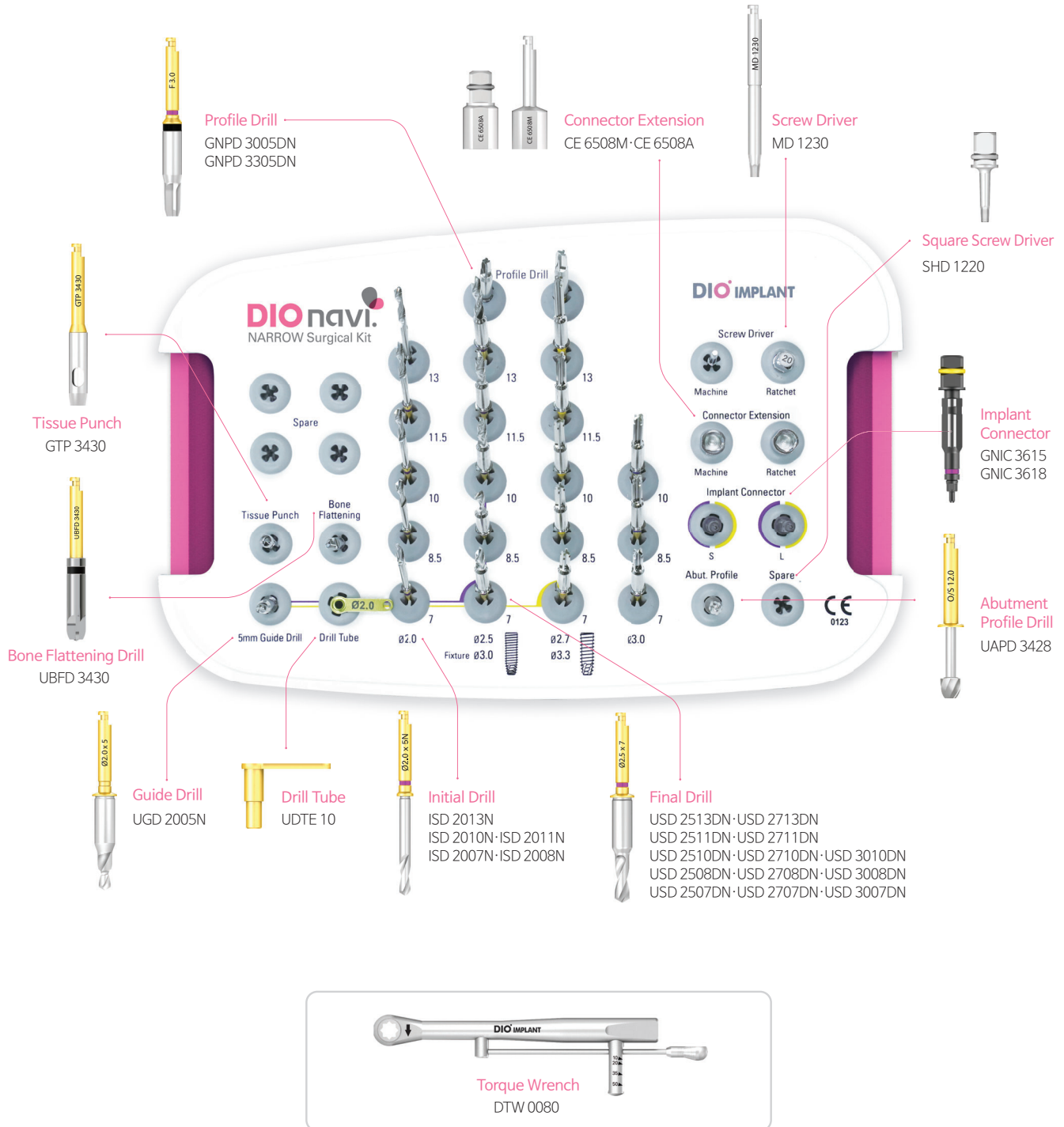

Surgical Tool

Tissue Punch

- Gingiva in the position of implant placement is incised into a round shape, and the inner double blade is used to remove the gum tissue cut into round shape.



Double blade
Gingiva can be removed stably using a fixed double blade inside the punch (flapless surgery).

Unit mm | Scale 1 : 1.15

K D Ø2.8

Code

GTP 3430

Bone Flattening Drill

- Alveolar crest surface is flattened, and soft tissue remaining in the alveolar crest is removed after using the tissue punch.

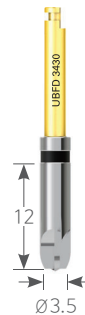

Quadruple blade
A quadruple blade is used for stable drilling of the hard alveolar ridge.

Unit mm | Scale 1 : 1.15

K D Ø3.5

Code

UBFD 3430

Guide Drill

- A hole in the bone is initially formed on the bone for easier insertion of the initial drill.



Double stepped drill
Stable drilling can be done due to short double step drill. This is a basic drill to maintain the accuracy of the path.

Unit mm | Scale 1 : 1.15

K D Ø2.0

Code





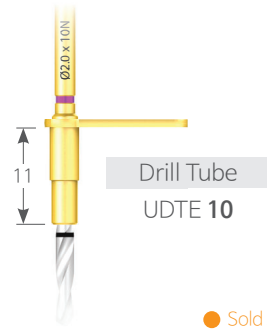

UGD 2005N

Initial Drill

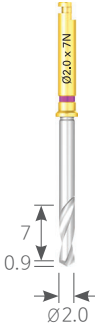
· It secures accurate depth and direction of drilling performed after achieving accurate hole formation during the initial steps.



● Sold separately
Unit mm | Scale 1 : 1

K D Ø2.0							ISD 2015N
Code	ISD 2007N	ISD 2008N	ISD 2010N	ISD 2011N	ISD 2013N	ISD 2015N	
							

Drill Tube

· To fix the guide drill and the initial drill without shakage.





Unit mm | Scale 1 : 1.15

K			
Code		UDTE 10	

Profile Drill

· Used to further drill cortical bone in the mandible with bone density of D1 or D2 for the purpose of preventing excessive torque.

K			
Fixture Size		Ø3.0	Ø3.3
Code		GNPD 3005DN	GNPD 3305DN
Color			



Surgical Tool

Final Drill

· Drilling is done by moving down along the passage of leading drill without using a drill tube, while increasing drill size (diameter) according to implant size.

K D Ø2.5

● Sold separately

Unit mm | Scale 1:1

Code USD 2507DN USD 2508DN USD 2510DN USD 2511DN USD 2513DN **USD 2515DN**



Length | 7 8.5 10 11.5 13 15

K D Ø2.7

Unit mm | Scale 1:1

Code USD 2707DN USD 2708DN USD 2710DN USD 2711DN USD 2713DN **USD 2715DN**



Length | 7 8.5 10 11.5 13 15

K D Ø3.0

Unit mm | Scale 1:1

Code USD 3007DN USD 3008DN USD 3010DN **USD 3011DN**

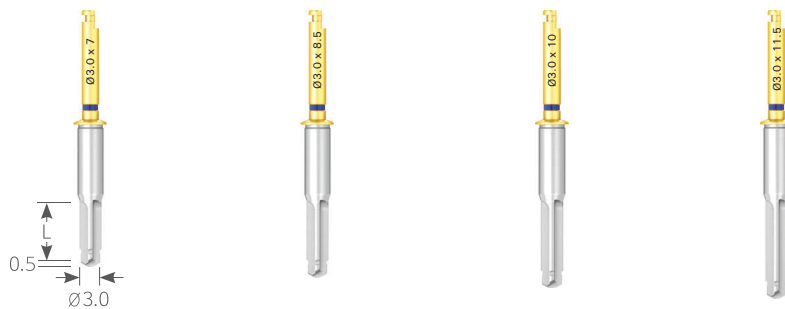

Length | 7 8.5 10 11.5

Abutment Profile Drill

· Shape of abutment profile is formed by rotating the functional drill 360 degrees which removes the disruptive alveolar bone around the abutment or H-Scanbody.

K D Ø3.4

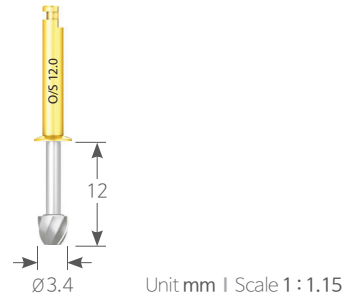

Code

UAPD 3428

Tap Drill

· Uses 3.6 Sleeve (GSL 36YE : Yellow)

K Hex 1.7

● Sold separately

Unit mm | Scale 1 : 1

Code

GNTD 3018DN

GNTD 3318DN



Color

Implant Connector

· If depth of placement and position of fixture hexagon are aligned with the guide sleeve projection during placement of the fixture, it is aligned with hex direction of the premade customized abutment.

K Hex 1.7

Unit mm | Scale 1 : 1

Code

GNIC 3615

GNIC 3618



Type

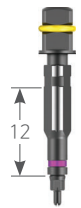

Short

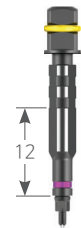

Long

Connector Extension

· Length of the connector is extended during implant placement.

K

● Sold separately

Unit mm | Scale 1 : 1.2

Code

CE 6508A

CE 6508M

CE 6512A

CE 6512M

Type



Ratchet



Machine



Ratchet





Machine

Surgical Tool

Screw Driver Machine

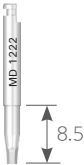
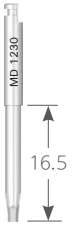
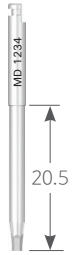
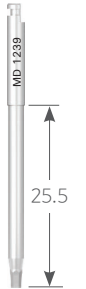
K Hex 1.2 ● Sold separately
Unit mm | Scale 1:1

Code	MD 1219	MD 1222	MD 1230	MD 1234	MD 1239
					

 1.2

Screw Driver Ratchet

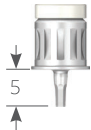
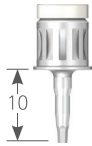
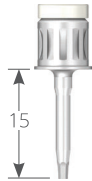
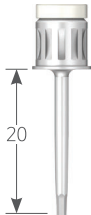
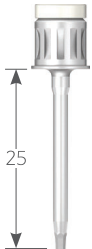
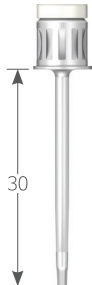

K Hex 1.2 Unit mm | Scale 1:1

Code	HD 1205A	HD 1210A	HD 1215A	HD 1220A	HD 1225A	HD 1230A
						

 1.2

Square Screw Driver

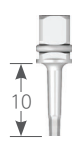
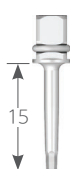
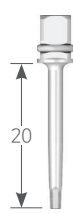
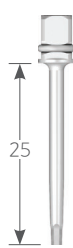
K Hex 1.2 ● Sold separately
Unit mm | Scale 1:1

Code	SHD 1210	SHD 1215	SHD 1220	SHD 1225	SHD 1230
					

DIOnavi. Wide Kit Kit Code | UF 11

- Kit composed of drill with outstanding cutting force and durability, etc.
- UF II Regular $\varnothing 5.5$ / UF II Wide $\varnothing 5.9$ $\varnothing 6.4$ Fixture
- Guide Sleeve : GS 68GN

Unit mm | Drill Scale 1 : 0.9

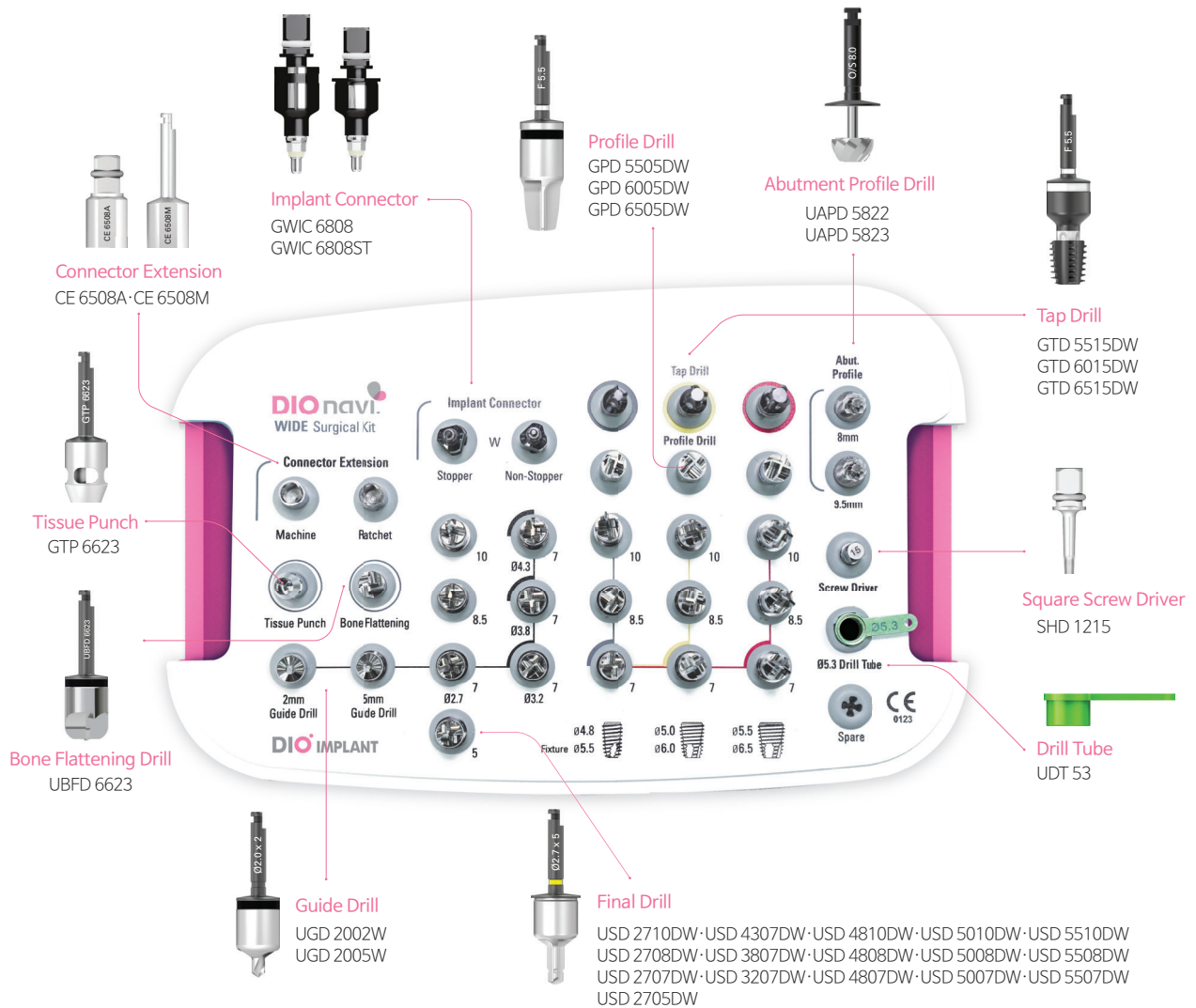

Surgical Tool

Tissue Punch

· Gingiva can be removed stably using a fixed blade inside the punch



Ø4.5

Unit mm | Scale 1 : 1.15

K D Ø4.5

Code

GTP 6623

Bone Flattening Drill

· Irregular alveolar crest surface is flattened.



1.5

8

Unit mm | Scale 1 : 1.15

K

Code

UBFD 6623

Drill Tube



K

Unit mm | Scale 1 : 1.2

Code

UDT 53

Guide Drill

· A hole is initially formed on the bone for easier insertion of the initial drill.

K D Ø2.0

Unit mm | Scale 1 : 1

Code

UGD 2002W

UGD 2005W



Final Drill

· The drill hole is expanded to the final drilling.

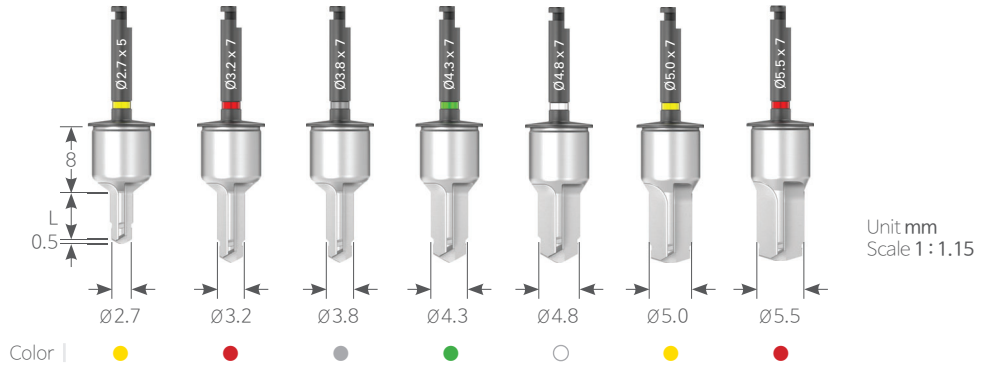

K D Ø2.7

Unit mm | Scale 1:1

Code	USD 2705DW	USD 2707DW	USD 2708DW	USD 2710DW
------	------------	------------	------------	------------

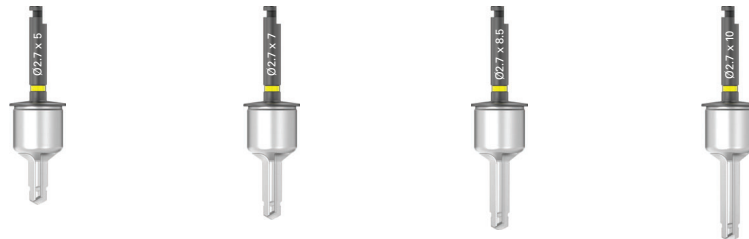

Length		5	7	8.5	10
--------	--	---	---	-----	----

K Length 7

Unit mm | Scale 1:1

Code	USD 3207DW	USD 3807DW	USD 4307DW
------	------------	------------	------------



Diameter		Ø3.2	Ø3.8	Ø4.3
----------	--	------	------	------

Surgical Tool

K D Ø4.8

Unit mm | Scale 1 : 1

Code	USD 4807DW	USD 4808DW	USD 4810DW
------	------------	------------	------------



Length

7

8.5

10

K D Ø5.0

Unit mm | Scale 1 : 1

Code	USD 5007DW	USD 5008DW	USD 5010DW
------	------------	------------	------------



Length

7

8.5

10

K D Ø5.5

Unit mm | Scale 1 : 1

Code	USD 5507DW	USD 5508DW	USD 5510DW
------	------------	------------	------------



Length

7

8.5

10

Profile Drill

· Used to further drill cortical bone in the mandible with bone density of D1 or D2 for the purpose of preventing excessive torque

K				Unit mm Scale 1 : 1
Fixture Size	Ø5.5	Ø6.0	Ø6.5	
Code	GPD 5505DW	GPD 6005DW	GPD 6505DW	



Tap Drill

· Excessive implant placement torque is prevented.

K				Unit mm Scale 1 : 1
Fixture Size	Ø5.5	Ø6.0	Ø6.5	
Code	GTD 5515DW	GTD 6015DW	GTD 6515DW	

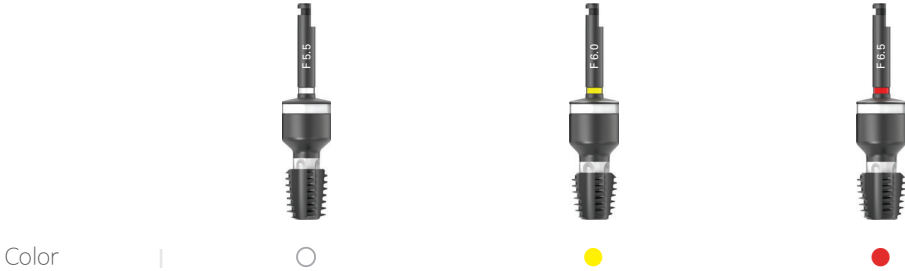

Connector Extension

· Length of the connector is extended during implant placement.

K			Unit mm Scale 1 : 1.1
Code	CE 6508A	CE 6508M	



Surgical Tool

Abutment Profile Drill

· The cortical bone disrupting sitting of the abutment is removed, and emergence profile is formed.

K D Ø5.8 Unit mm | Scale 1:1

Code	UAPD 5822	UAPD 5823
Offset	 8	 9.5

Implant Connector

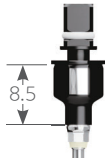
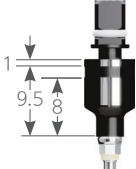
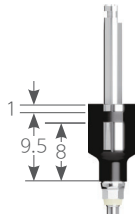

· Implant is placed according to depth of the fixture and direction of the internal hex planned in advance.
· Be careful about excessive torque of 50Ncm or above.

K ● Sold separately
Unit mm | Scale 1:1

Code	GWIC 6808ST	GWIC 6808	GWICC 6808
Type	 Stopper	 Non-Stopper	 Machine Non-Stopper
Offset	8	8 / 9.5	8 / 9.5

Square Screw Driver

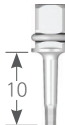
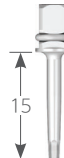
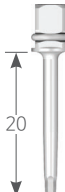
K Hex 1.2 ● Sold separately
Unit mm | Scale 1:1

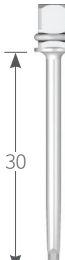
Code	SHD 1210	SHD 1215	SHD 1220	SHD 1225	SHD 1230
Offset	 10	 15	 20	 25	 30

DIONavi. Flapless Crestal Sinus Kit Kit Code | SMK 02



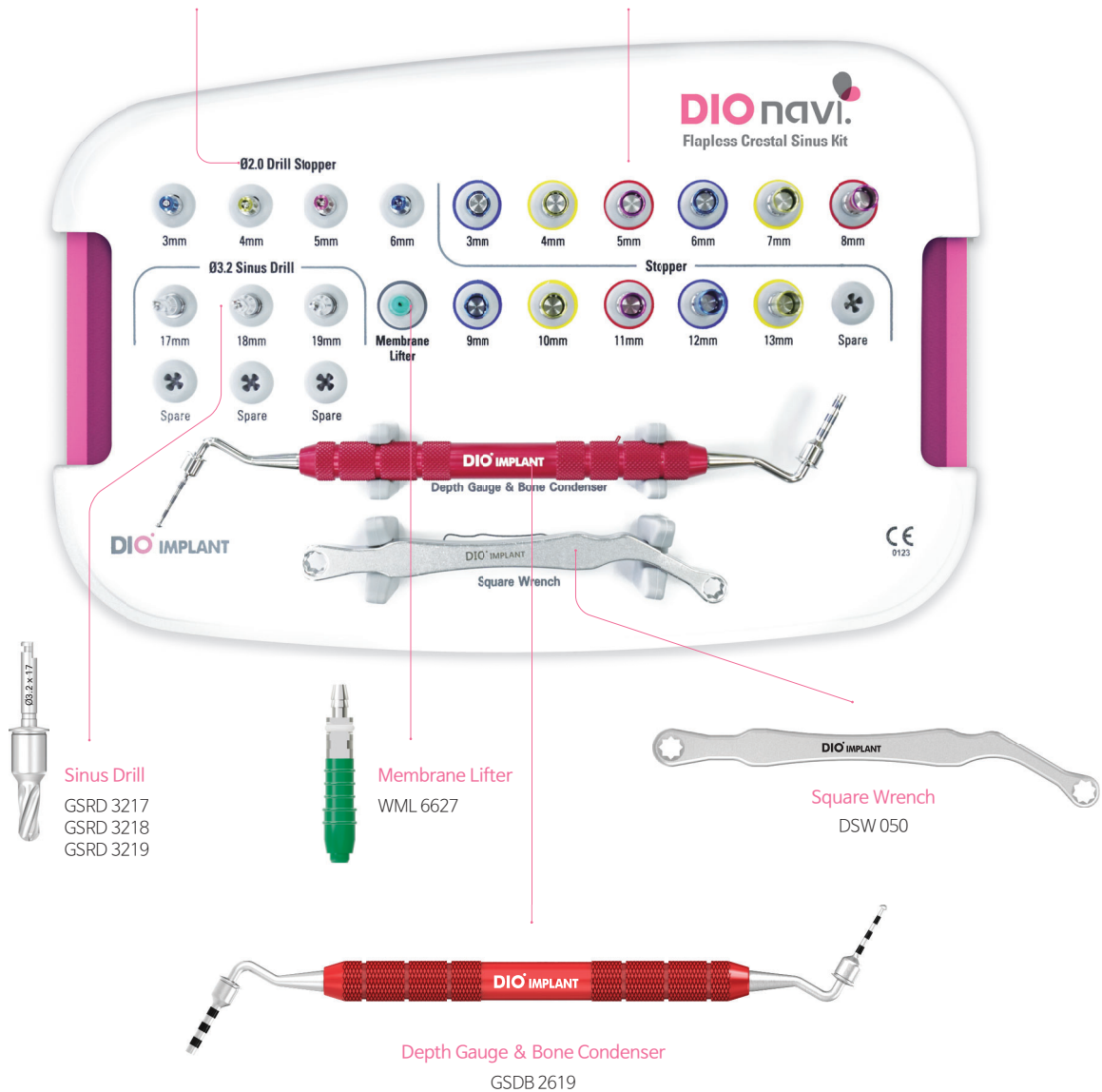

Unit mm | Drill Scale 1 : 0.9



Surgical Tool



Ø2.0 Drill Stopper

- This is used to connect to the Ø2.0 initial drill of DIOnavi. Master to maintain constant depth during surgery.
- Range of length is 3~6mm with 1mm interval and anodizing and laser marking are done for each length.

K		Unit mm Scale 1:1			
Code	GST 2030BL	GST 2040YE	GST 2050RD	GST 2060BL	
					

Sinus Drill

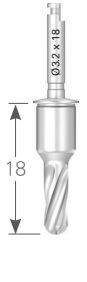
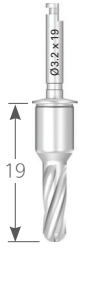
- Dome shaped tip is designed to prevent damaging of the membrane during drilling.
- Depth must be adjusted using a stopper.
- Non-irrigation and low-speed drilling (10rpm)

K D Ø3.2		● Sold separately Unit mm Scale 1:1			
Code	GSRD 3217	GSRD 3218	GSRD 3219	GSRD 3221	
					

Ø3.2 Drill Stopper For crestal approach

- This is used by connecting to the Ø3.2 round drill of Flapless Crestal Sinus Kit.
- Range of length is 3~13mm with 1mm interval to maintain constant depth during surgery. Anodizing and laser marking are done for each length.

K		Unit mm Scale 1:1					
Code	GST 03BL	GST 04YE	GST 05RD	GST 06BL	GST 07YE	GST 08RD	
							
Code	GST 09BL	GST 10YE	GST 11RD	GST 12BL	GST 13YE		
							

Depth Gauge & Bone Condenser

- After checking the thickness of the residual bone and whether the membrane is lifted, push in the bone into the lifted sinus.
- After separating the Guide, make sure to use it attaching the Stopper.

K	Unit mm
Code	GSDB 2619



Membrane Lifter

- Single use only

K	Unit mm
Code	WML 6627



Square Wrench

K	Unit mm
Code	DSW 050



Saline Tube

- Syringe ※ Separately sold product
- Single use only

K	● Sold separately	Unit mm
Code	MLT 40300	

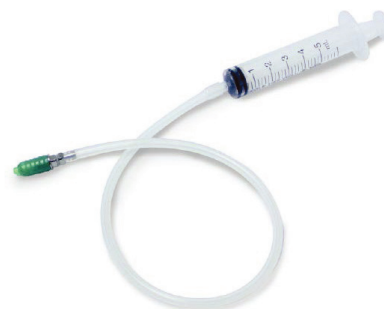

DIOnavi. Special Kit Kit Code I SGF 02

· Kit composed of drill with outstanding cutting force and durability, etc.

Unit mm | Drill Scale 1 : 0.9

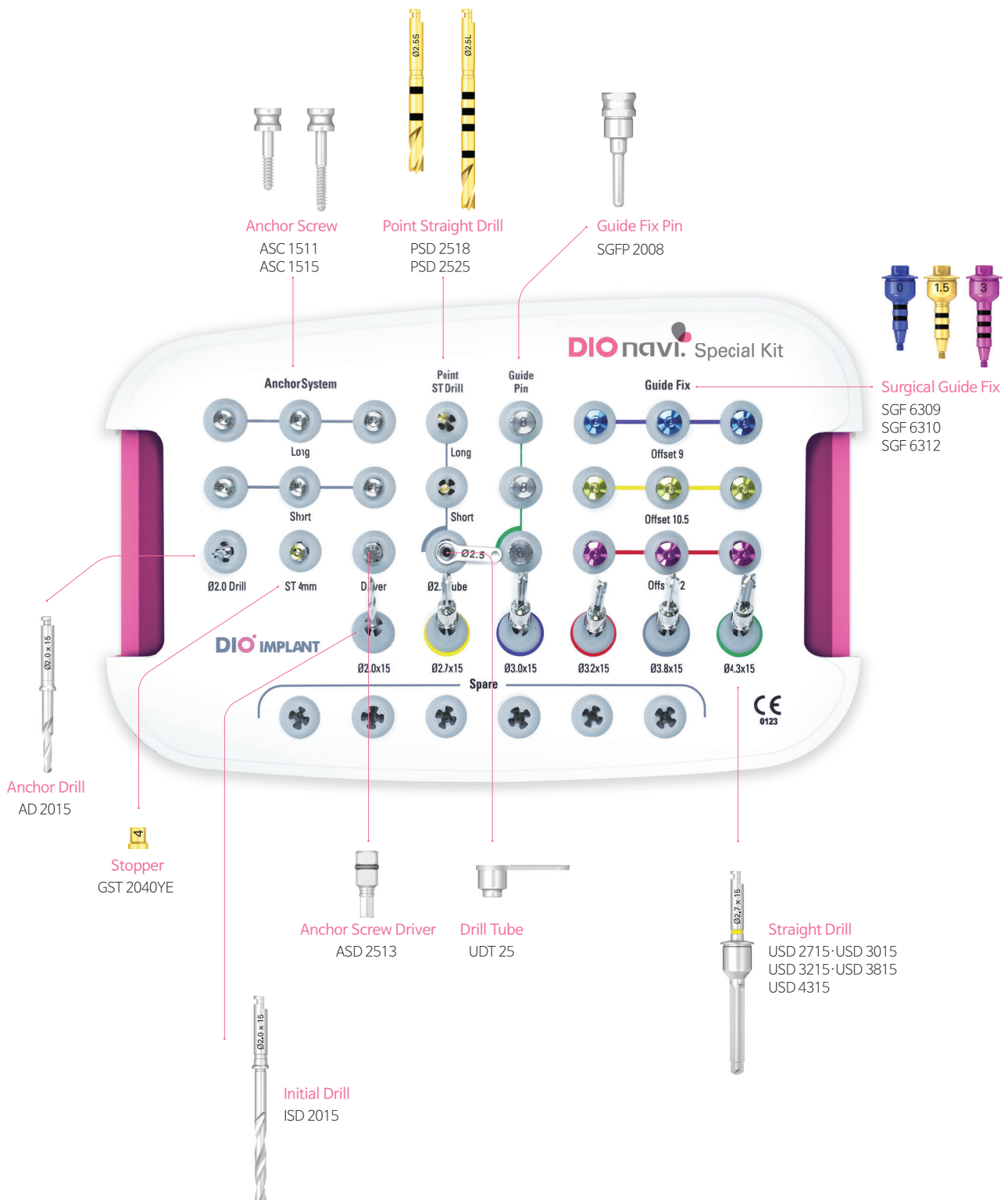

Surgical Tool

Anchor Drill

- A hole is formed to insert an anchor pin into the bone for the purpose of fixating the surgical guide.

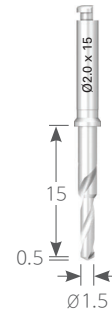

Unit mm | Scale 1 : 1.15

K D Ø1.5

Code

AD 2015

Stopper

- This is used when connecting to the Ø2.0 initial drill.
- Constant depth is maintained during surgery.



Unit mm | Scale 1 : 1.15

K D Ø2.9

Code

GST 2040YE

Anchor Screw

- Used to connect the anchor screw using an anchor screw driver for ratchet

K D Ø2.0

Unit mm | Scale 1 : 1

Code

ASC 1511

ASC 1515

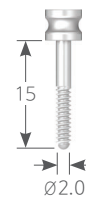
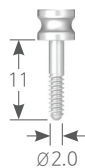

Anchor Screw Driver

- Used to connect the anchor screw using an anchor screw driver for ratchet



K

Unit mm | Scale 1 : 1.15

Code

ASD 2513

Surgical Tool

Initial Drill



K D Ø2.0

Unit mm | Scale 1 : 1.15

Code

ISD 2015

Point Straight Drill

- Use of a drill tube (UDT 25) exclusive for the instrument (with a shape that prevents slipping on the bone) to form the guide hole in accurate position

K D Ø2.5

Unit mm | Scale 1 : 1

Code



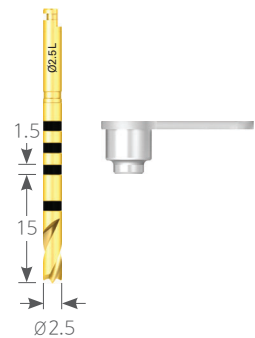
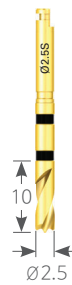

PSD 2518

PSD 2525



Straight Drill

K Length 15 Unit mm | Scale 1 : 1

Code	USD 2715	USD 3015	USD 3215	USD 3815	USD 4315
Color					

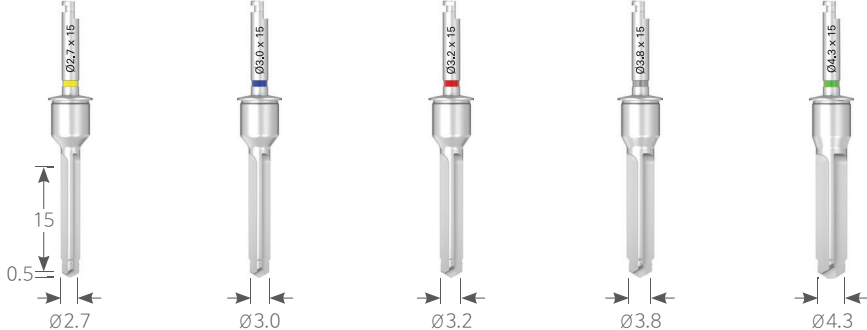

Guide Fix Pin

- Used after $\varnothing 2.0$ drilling to insert a surgical guide fix pin into the hole to fix the surgical guide in place and prevent shaking (side shaking is prevented after fixing)



K Unit mm | Scale 1 : 1.15

Code	SGFP 2008
------	-----------

Surgical Guide Fix

- Used to fix the surgical guide in place and prevent movement by connecting to the fixture placed earlier (side shaking is prevented after fixing)

K Unit mm | Scale 1 : 1

Code	SGF 6309	SGF 6310	SGF 6312
Offset	 9	 10.5	 12

Surgical Tool

Metal Needle

- Place the Metal needle tip deep into the osteotomy site, in order to prevent any damage caused by over-heating of the bone and complete removal of remaining tissues and particles at drilled bone cavity.
- Recommended capacity of the syringe : 30~50cc (Refrigerate before surgery)

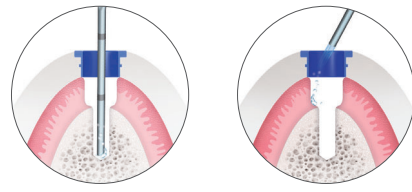
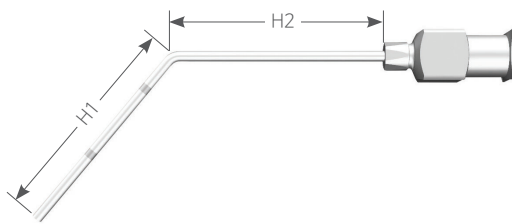

O Place the metal needle tip deep into the osteotomy site.

X With the needle tip not all the way down to osteotomy it is hard to irrigate

● Sold separately

Unit mm | Scale 1 : 1.15

Code	K	
	MNTE	MNTL
Height 1	30	25
Height 2	50	25

DIONavi. Drill Plate

- To increase efficiency and convenience of sterilizing drills and restoring them into the KIT set after DIONavi. Surgery
- Sterilizable material
- Size : 200×140×30(mm)
- ※ Non-medical devices



● Sold separately

Unit mm

Code	K	
	NP 01	

Surgical Kit

Sinus Master Kit Kit Code I SMK 01

· **Crestal Approach Technic**

Sinus Technic based on low-speed drilling (50~100rpm) and stopper that perforates the inferior cortical wall and lifts the membrane safely and quickly

· **Lateral Approach Technic**

Round drill or core drill can be selected. The membrane can be lifted safely and quickly based on low-speed drilling (50~100rpm) and stopper.

Unit mm | Drill Scale 1 : 0.9

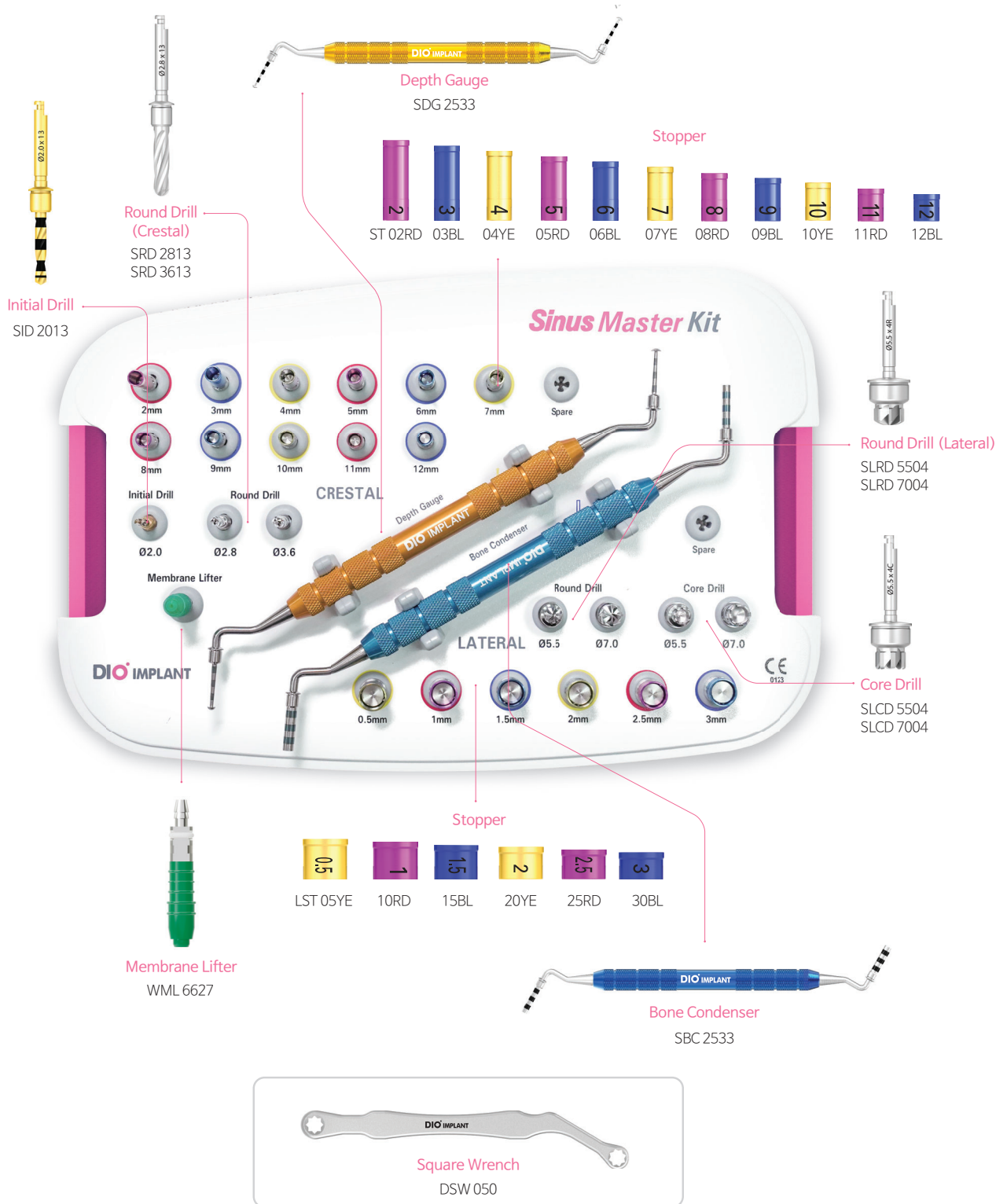

Surgical Tool Crestal

Ø2.0 Intial Drill

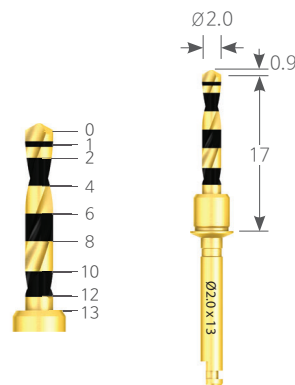

K D Ø2.0

Unit mm | Scale 1 : 1.2

Code

SID 2013

Round Drill

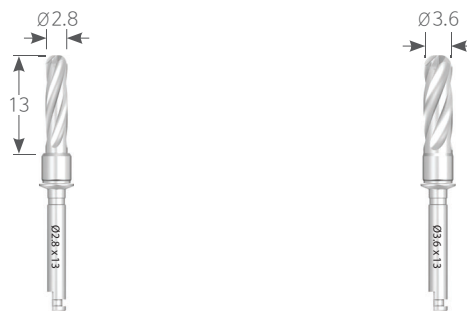

K Length 13

Unit mm | Scale 1 : 1.2

Code

SRD 2813

SRD 3613

Stopper

· Stopper must be used for adjusting depth of the drill. It is distinguished by color and number.

K

Unit mm | Scale 1 : 1

Code	ST02RD	03BL	04YE	05RD	06BL	07YE	08RD	09BL	10YE	11RD	12BL
------	--------	------	------	------	------	------	------	------	------	------	------



Drilling Length	2	3	4	5	6	7	8	9	10	11	12
Stopper Length	15	14	13	12	11	10	9	8	7	6	5

Surgical Tool Crestal

Membrane Lifter

· Single use only



K

Unit mm | Scale 1 : 1.2

Code

WML 6627

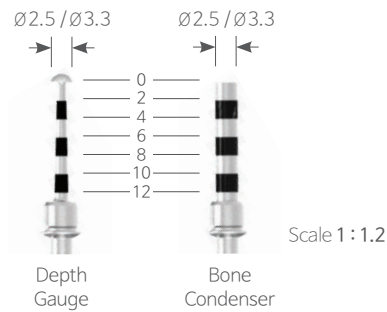

Depth Gauge

K

Unit mm

Code

SDG 2533



Bone Condenser

K

Unit mm

Code

SBC 2533



Surgical Tool Lateral

Round Drill

K	Unit mm Scale 1 : 1					
Code	SLRD 5504		SLRD 7004			

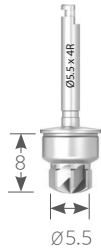

Core Drill

K	Unit mm Scale 1 : 1					
Code	SLCD 5504		SLCD 7004			

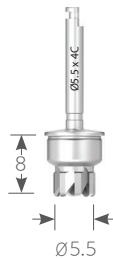

Stopper

· Stopper must be used for adjusting depth of the drill. It is distinguished by color and number.

K	Unit mm Scale 1 : 1					
Code	LST 05YE	10RD	15BL	20YE	25RD	30BL



Drilling Length	0.5	1	2	1.5	2.5	3
Stopper Length	7.5	7	6	6.5	5.5	5

Surgical Protocol

Lateral Approach Technic

- Sinus Technic based on low-speed drilling (50~100rpm) and stopper that perforates the inferior cortical wall and lifts the membrane safely and quickly

Drilling Round Drill

Rounded tip to perform drilling

Caution

The stopper must be used. Irrigation at 1,200~1,400rpm

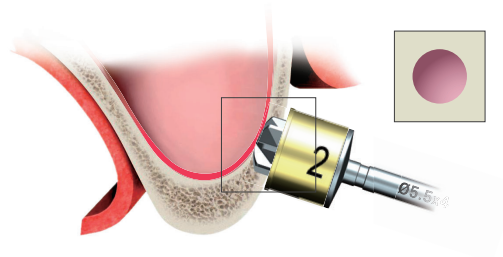

Drilling Core Drill

The edge of the rounded tip only can perform drilling
Beware of the remaining bone chips returning to original position after lifting of the maxillary sinus.

Caution

The stopper must be used. Irrigation at 600~800rpm

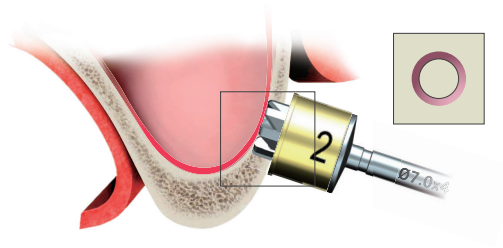

Lifting of the sinus membrane Sinus Lift

Lifting of the membrane on the lateral side

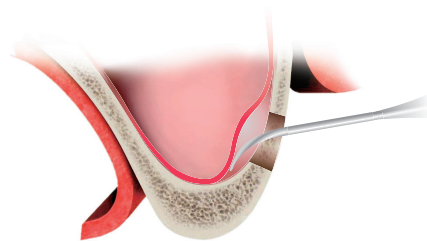

Crestal Approach Technic

- Sinus Technic based on low-speed drilling (50~100rpm) and stopper that perforates the inferior cortical wall and lifts the membrane safely and quickly

Drilling Initial Drill

Drilling is done 1~2mm short from the floor of the maxillary sinus measured by CT after attaching a stopper.

Caution

The stopper must be used to adjust depth.
Non-irritation and low-speed drilling at 50rpm

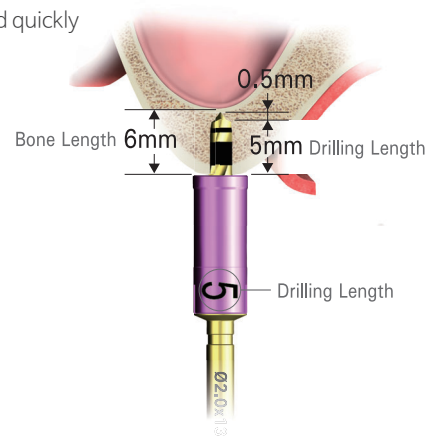

Sinus drill to perforate the bone underneath the maxillary sinus

Drilling is done to the same length as height of the residual bone of the maxillary sinus measured on CT after attaching a stopper.

Caution

The stopper must be used to adjust depth.
Non-irritation and low-speed drilling at 50rpm

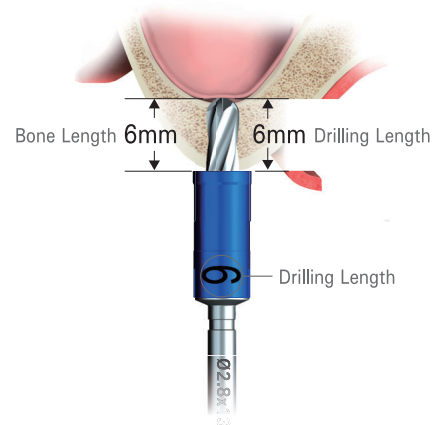

Membrane lifter to lift the sinus membrane

The membrane lifter is used to inject saline solution into the osteotomy site.

Caution

Amount of injection measurement starts when pressure is felt, excluding the first 0.2cc~0.5cc before pressure is applied.

※ Amount of injection before pressure can differ according to height and expansion of the bone. For 1mm of sinus lifted, 0.1cc is injected.

Caution

If inferior border (A) of the maxillary sinus is well open

If pressure can be felt during injection of saline solution, the membrane is lifted and the pressure drops and saline solution injected.

If inferior border (A) of the maxillary sinus is not open well

After pressure felt from injection of saline solution, no more pressure can be applied or the nozzle is pushed out.

→ Drill the sinus drill 1mm deeper and retry.

Aspiration of saline solution with the nozzle kept in the hole

If negative pressure results after aspiration of injected saline solution mixed with blood, the membrane is fully lifted.

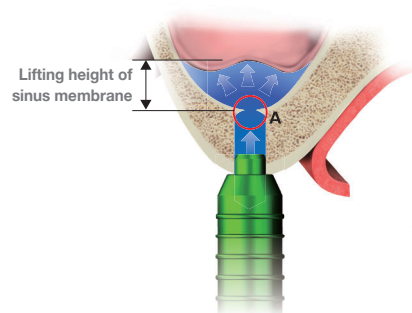

Surgical Protocol

Sinus drill (2nd) to open and expand inferior border of the maxillary sinus.

After lifting the maxillary sinus membrane, the sinus drill is used to drilled 1mm deeper to expand the entrance of inferior border of the maxillary sinus.

Caution The stopper must be used to adjust depth.

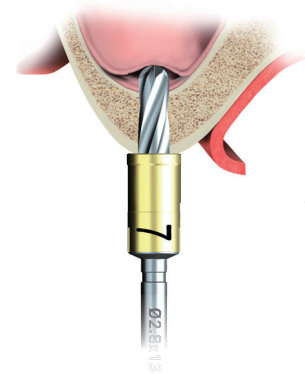
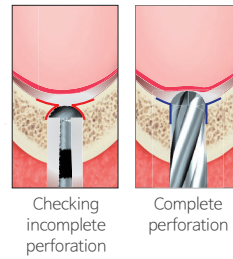

Bone condenser to inject bone graft material

The bone condenser is used to push bone graft material into the maxillary sinus through the osteotomy site.

Caution

The stopper must be used to adjust depth.

Non-irrigation, low-speed drilling at 50rpm.

Caution

Determine volume of bone graft material.

When pressure is felt during injection of saline solution, the membrane is lifted.

Lifting height of the sinus membrane (mm)	1	2	3	4	5	6	7	8	9	10
Gone graft GBR (cc)										
If implant is placed	0.1	0.2	0.3	0.4	0.5	0.6	0.7	0.8	0.9	1.0
If implant is not placed	0.3	0.6	0.9	1.2	1.5	1.8	2.1	2.4	2.7	3.0

Dispersion of bone graft material

Insert a depth gauge into the maxillary sinus and rotate it to evenly disperse bone graft material.

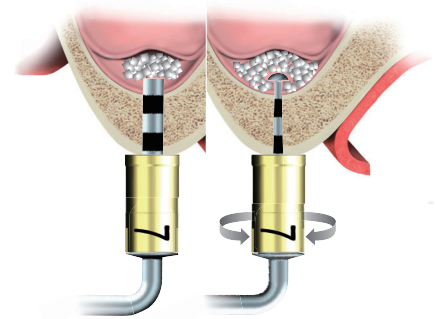

Final Drilling Final Drill

Drill 2mm deeper than depth of the sinus drill used earlier.

Caution Use a drill shorter than implant.

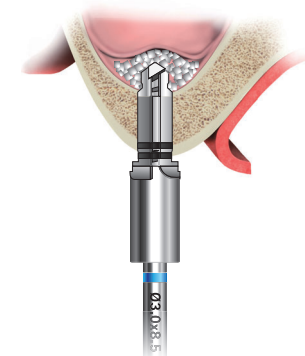

Sinus drill (2nd) to open and expand inferior border of the maxillary sinus

Implant that enters into the maxillary sinus pushes bone graft material away to disperse it. If amount of residual bone is 4mm or larger, satisfactory initial fixing force can be obtained. Also, temporary prosthesis can be restored immediately upon placement of implant.

Caution

If remaining bone is very thin with thickness of 3mm or less and initial fixing of impalnt fails, only bone graft on the maxillary sinus is performed without implant placement.

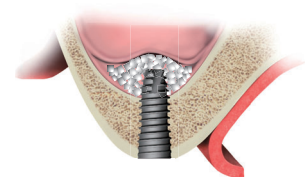

Dr.SOS+ Kit Kit Code | DRS 02

· Problems like fracture of screw from excessive torque, wearing of connections, and jamming of foreign matters during prosthetic part of implant installation are resolved safely and quickly.

Unit mm | Drill Scale 1 : 0.9

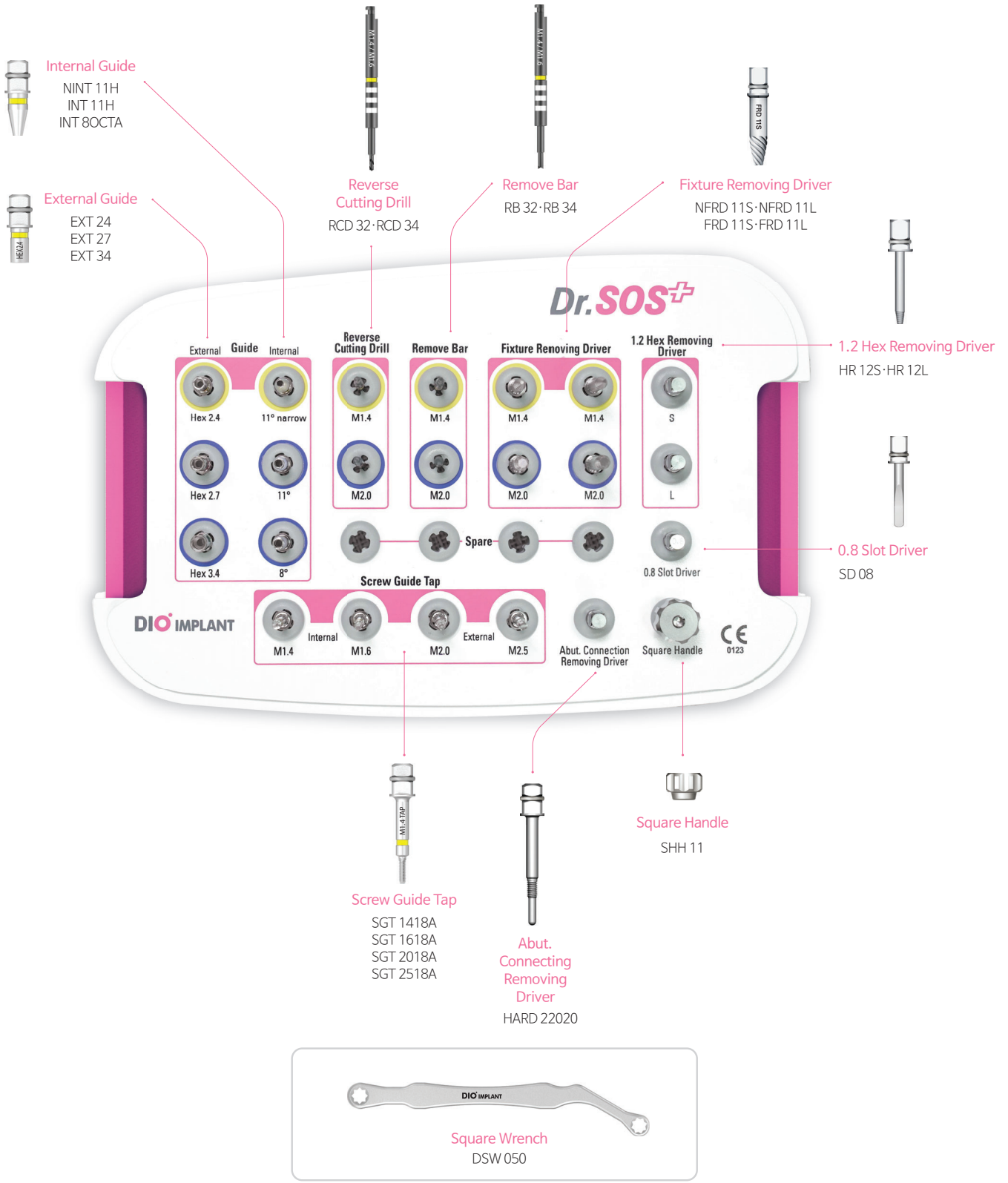

Surgical Tool

Internal Guide

· Guide for accurate entry of the Remove Bar and Reverse Cutting Drill into the fixture

K UFII Narrow



Unit mm | Scale 1:1

Code	NINT 11H	NINT 11N
Type	 Hex	 Non-Hex

K UFII Regular / Wide

Code	INT 11H	INT 11N
Type	 Hex	 Non-Hex







K Non-Sub. 8°

Code	INT 8Octa	INT 8N
Type	 Octa	 Non-Octa

External Guide

K Hex

Unit mm | Scale 1:1



Code	EXT 24	EXT 27	EXT 34
	  2.4	  2.7	  3.4

Reverse Cutting Drill

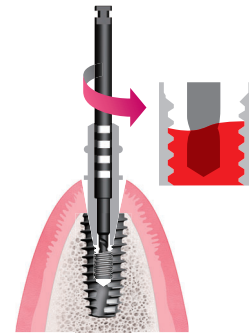
- After inserting the end blade of the cutting drill in the fractured screw remains, remove the remains in a reverse rotation by friction.
- When it is difficult to remove with a reverse cutting drill, remove the screw remains by inserting a 1.2 hex removing driver on the hole formed on the screw remains and drilling in a reverse rotation



※Drill Speed : 1,200RPM / Reverse rotation
 ※In order to prevent high heat generation, osteotomy irrigation is necessary.



K		Unit mm Scale 1 : 1	
Code	RCD 32	RCD 34	
Type	 M1.4 / 1.6	 M2.0 / 2.5	

Remove Bar

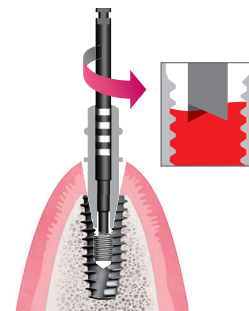
- By attaching the end blade of the bar to the cross section of the fractured screw remains, remove the remains in a reverse rotation by friction



※ Drill Speed : 15rpm / Reverse rotation

K		Unit mm Scale 1 : 1	
Code	RB 32	RB 34	
Type	 M1.4 / 1.6	 M2.0 / 2.5	

Surgical Tool

Fixture Removing Driver

· Allows the removal of placed implant by inserting to the fixture and turning anti-clockwise.

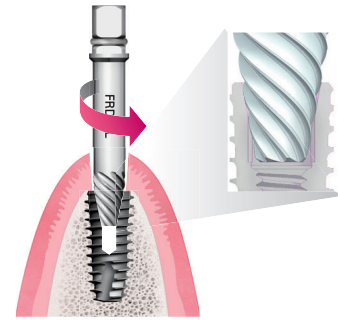

K

Unit mm | Scale 1 : 1

Fixture Size	UFII Narrow · External NF		UFII Regular · Wide	
Code	NFRD 11S	NFRD 11L	FRD 11S	FRD 11L



Type

Short

Long

Short

Long

1.2 Hex Removing Driver

· When use of the 1.2 Hex driver is not possible due to microorganisms in the 1.2 Hex connection part or the screw is stripped, use the removing driver for the removal of abutments or screws by inserting and turning anti-clockwise.

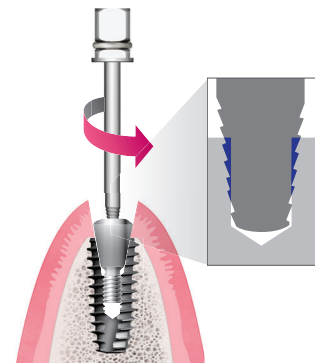

K Hex 1.2

Unit mm | Scale 1 : 1

Code	HR 12S	HR 12L
------	--------	--------



0.8 Slot Driver

- If removal with the driver is not possible due to severe wear in the connection part, use the bur to create a slot with a minimal depth of 1mm and remove using the 0.8 Slot driver.

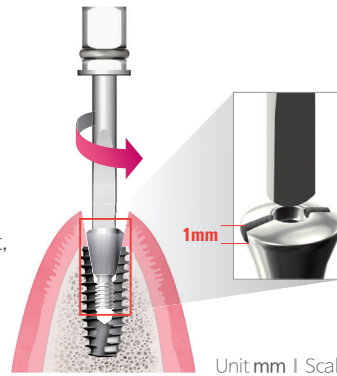

Unit mm | Scale 1 : 1

K

Code

SD 08



Abutment Connection Removing Driver

- If there is fractured residue remaining in the abutment connection part which is impossible to remove, attach the removing driver to the inner fixture and turn clockwise to contact the driver end with the bottom, for removal.

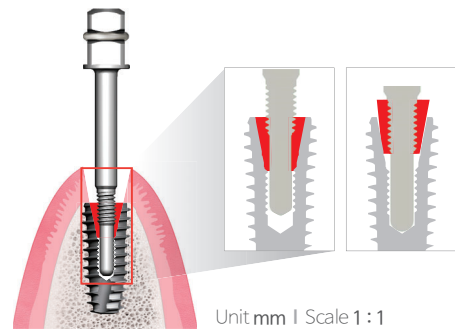

Unit mm | Scale 1 : 1

K

Code

HARD 22020

Screw Guide Tap

- Allows the restoral of distorted or damaged screw threads which hinder abutment-to- fixture attachment, caused by the penetration of microorganisms in the connection part or stripping of the screw thread.

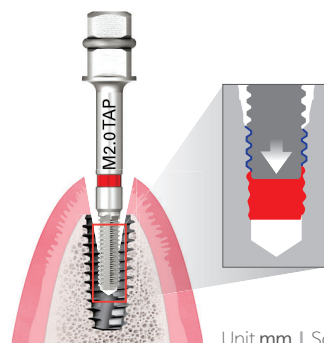

Unit mm | Scale 1 : 1

K UF II Narrow / External Narrow

Code

SGT 1418A

SGT 1618A

SGT 2018A

SGT 2518A



Ø1.4



Ø1.6



Ø2.0



Ø2.5

Color



※ This catalog contains all products of DIO Corporation.

Please check with your local sales office and your sales representative if you are able to order products.

